

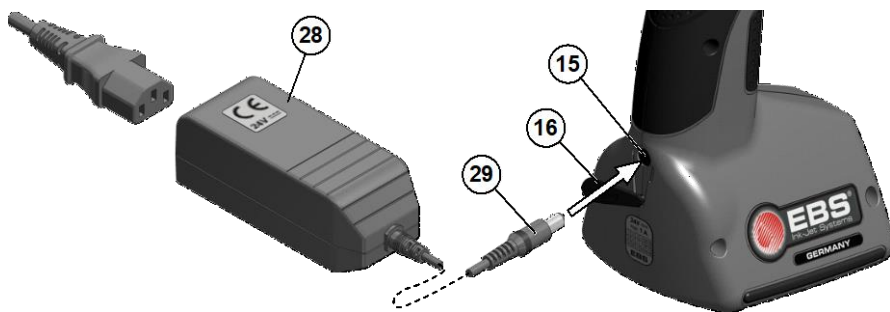

- ▶ [Operating Manual](#)
- ▶ [version: 20191021#1.1](#)
- ▶ [EN](#) English

HANDJET[®] EBS-260

A**B**

C**EN**

Components of Portable Printer System

See the figures: **A B C**.

1. Upper guide roll.
2. Nozzle plate - front part of the print head (ink outlet).
3. Lower guide roll, to synchronize printing.
4. Laser pointer (shows the position of the lowest nozzle during printing).
5. Openings with plugs for adjusting electromagnets.
6. Trigger – a print release button, also used by other functions.
7. Printer base, battery and magnet compartment.
8. Printer holder.
9. USB port with a cap.
10. Keypad.
11. Name plate.
12. LCD touch screen.
13. Ink container.
14. Ink container labels.
15. Battery charge socket.
16. Charge plug.
17. Guarantee seal.
18. Printer's ON/OFF button.
19. Printer ON LED indicator.
20. Battery charge LED indicator.
21. Radio communication LED indicator.
22. PRINT ON/OFF LED indicator (*Print on* state).
23. Print ON/OFF button.
24. Function key.
25. "+" key.
26. "-" key.
27. Printer middle line.
28. Power pack to charge printer batteries.
29. Plug of power pack **28**.
30. ► OPEN/CLOSED indicator for ink container.
31. Container valve.
32. Ink system needle.
33. Ink container gasket.
34. 🔊 Buzzer – a buzzing signal generator, located inside element **8** of the printer.

Signs

 Information signs indicating:

- ◆ that the actions described need to be taken with extra or special care,
- ◆ the printer's additional or specific functions or options, which are not described anywhere else,
- ◆ untypical behavior of the printer and other hints.

EN  **A warning not to perform the operation that might be unsafe or critical for the printer. It requires the user to follow closely the instructions given therein.**

A
B
C | Figure numbering notation

The meaning of LED and other indicators:

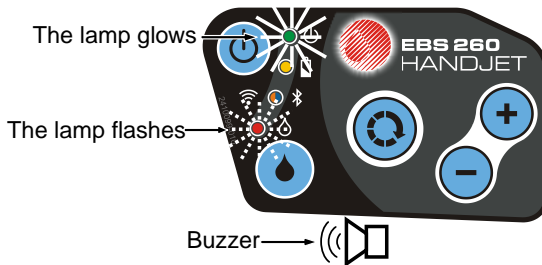











TABLE OF CONTENTS

 COMPONENTS OF PORTABLE PRINTER SYSTEM	3
 SIGNS	4
 APPLICATION	7
 OPERATIONAL SAFETY	7
GENERAL SAFETY INSTRUCTIONS	7
LASER RADIATION SAFETY	8
PROTECTING THE BATTERY PACK	9
WHEN INK OR WASH-UP SPILLS	9
CONTROL OF ELECTROMAGNETIC INTERFERENCE	10
IMPACT ON MEDICAL EQUIPMENT	10
PACEMAKER AND OTHER MEDICAL IMPLANTS.....	10
OTHER MEDICAL EQUIPMENT.....	10
OPERATION IN EXPLOSION HAZARD AREAS	10
OPERATION IN AREAS OF BLASTING	10
CONFORMITY MARKING	11
ENVIRONMENTAL PROTECTION	11
 PREPARING THE PRINTER FOR OPERATION AND SETTING BASIC PARAMETERS	12
OPERATING TOUCH SCREEN	12
SIMPLE MENU	14
LCD KEYPAD	14
SWITCHING THE PRINTER ON AND OFF	16
SWITCHING THE PRINTER ON.....	16
SWITCHING THE PRINTER OFF	16
Shutting the Printer Down in Emergency Shutdown Mode	18
LOGGING IN.....	18
INSTALLING AND REPLACING INK CONTAINER	19
INSTALLING INK CONTAINER IN THE PRINTER	19
INK LEVEL IN CONTAINER.....	20
REPLACING INK CONTAINER.....	20
GENERAL SETTINGS	21
DATE AND TIME SETTINGS	22
SOUND SETTINGS	23
ENERGY MANAGEMENT	25
CHARGING THE BATTERY.....	25
LOW-BATTERY INDICATOR	26
DISPLAY PARAMETERS SETTINGS	27
USER MANAGER	28
RADIO COMMUNICATION AMONG THE PRINTER, A COMPUTER AND EXTERNAL DEVICES	29
WIFI WIRELESS CONNECTION.....	29
Connecting the Printer to a New Network via WiFi	30
BLUETOOTH INTERFACE	32
Establishing Connection between Printer and External Device	32
CONNECTING USB DISC TO THE PRINTER	34
IMPORTING PROJECTS	35
EXPORTING PROJECTS.....	35
UPDATING SOFTWARE.....	36
MESSAGES	37
STATISTICS	39
 GETTING STARTED	40
OPERATING THE PRINTER VIA PRINTER TOUCH SCREEN	40
FILE MANAGER	40
CREATING A NEW PROJECT.....	41
OPENING AND EDITING A PROJECT.....	41
PROJECT PROCESSOR	42
Project Properties	43
List of Objects	44
Clipboard	44
Trash	45
Objects	46
<i>Repositioning an Object</i>	47
<i>Re-sizing an Object</i>	48
<i>Common Parameters of Objects</i>	48
<i>Text Object – Normal text</i>	51
<i>Text Object – Date/Time</i>	51
<i>Text Object – Counter</i>	53
<i>Text Object – Communications Port</i>	55
<i>Text Object – Text File</i>	59
<i>Shape-type Object – Line</i>	60
<i>Shape-type Object – Rectangle</i>	61
<i>Shape-type Object – Ellipse</i>	61
<i>Barcode</i>	62
<i>Image</i>	64
<i>Line Divider</i>	64
PRINTING PARAMETERS	65
PROJECT RECOVERY	68
SERVICE	69

Purging	70	Printers Network Manager	110
USB	71	Language Manager	111
Unlocking Options	71	Account Manager	112
Restoring Preliminary Settings	72	Workspace width	112
Tuning	73	Simulate Printout	113
Information	73	SETTINGS	113
OPERATING THE PRINTER VIA		General Settings	113
MOZILLA FIREFOX WEB BROWSER	74	SERVICE	114
ESTABLISHING CONNECTION		Update	114
BETWEEN PRINTER AND COMPUTER	74	Log	115
INSTALLING OFFLINE EBS WEB USER		Generate Service Report	115
INTERFACE	74	Install Option	116
LOGGING IN	74	LCD Preview	116
WORK SCREEN OF EBS WEB USER		PRINTER CONTROL	116
INTERFACE	74	INFO	117
FILE MANAGER	75	About	117
PROJECTS	76	Operating Statistics	117
Create a New Project	76	MESSAGES	117
Open and Edit a Project	76	 PRINTING	118
Import a Project	78	OPENING PROJECT FOR PRINTING	118
Export Project	79	OPENING A PROJECT FOR PRINTING	
Project Processor	80	VIA PRINTER LCD	118
Printing Parameters	83	OPENING A PROJECT FOR PRINTING	
Objects	86	VIA WEB BROWSER	119
<i>Common Parameters of Objects</i>	86	PRINTING A PROJECT	119
Text Objects	88	PRINTING A PROJECT VIA PRINTER	
<i>Text Object – Normal Text</i>	88	LCD	119
<i>Text Object – Date/Time</i>	89	PRINTING A PROJECT VIA WEB	
<i>Text Object – Counter</i>	91	BROWSER	122
<i>Text Object – Communications</i>		 MAINTENANCE, STORAGE	
<i>port</i>	93	AND TRANSPORT	123
<i>Text Object – Text File</i>	98	 USER SUPPORT	124
Image	99	PROBLEMS WITH FUNCTIONING AND	
Barcode	100	OPERATION OF THE PRINTER	124
Shape-type Objects	102	<i>Some of the nozzles do not jet</i>	
<i>Shape-type Object – Line</i>	102	<i>ink</i>	124
<i>Shape-type Object – Rectangle</i> ..	103	<i>The printer does not print</i>	124
<i>Shape-type Object – Ellipse</i>	104	<i>Boldfaced or Blurred Prints</i>	124
Line Divider	104	QUESTIONS AND PROBLEMS	125
List of Objects	105	 TECHNICAL PARAMETERS	125
Clipboard	106	PRINTER ACCESSORIES	128
Trash	106		
TOOLS	106		
Image Manager	106		
Font Manager	107		
Text Files Manager	108		
Users Manager	109		

Dear Users of EBS Ink Jet Systeme equipment,

Please read this manual necessarily in order to get full information about the operation of your device.

Disclaimer:

- *We shall bear no responsibility for damage to the device if it is operated improperly, i.e., inconsistently with this manual.*
- *The application and use of the products are beyond our control and therefore fall exclusively into your scope of responsibility.*
- *As we wish to keep pace with permanently progressing technological development and individual requirements of our clients, we need to reserve the right to change the form, make and technical solutions of our devices. Therefore no data, illustrations or descriptions of this manual shall form any grounds for claims.*
- *We spare no effort to ensure that this manual is reliable, includes all modifications and is free from errors. However, the drawing up and publication process is complex and an error can occur in spite of our endeavors and wishes. We shall bear no responsibility for the consequences of editorial and printing errors in this manual.*

If your device contains a particular piece of equipment or needs performing an operation that have not been illustrated or described in this manual, or if you have queries on reading this manual, please contact any representative of EBS Ink Jet Systeme for additional information.

This manual applies to Offline EBS Web User Interface (Offline WUI) in version 1.4 and the EBS-260 printers equipped with the control system in version 1.02.08. In order to view the printer system version go to:

- ◆ *On the printer LCD: Tools – Service – Information – System Version,*
- ◆ *In EBS Web User Interface (WUI): Info – About – System version.*

Application

The HANDJET® EBS-260 printer is designed for marking, labeling, putting prints and simple graphics wherever the use of a manual labeling device is required or preferred.

Prints are put on articles with the application of the INK-JET method.

Operational Safety



Before you start your printer for the first time read the hints given below and follow the underlying principles for your own and other persons' safety.

General Safety Instructions

1. The printer must not be operated in rooms where explosion hazard exists.

2. No prints can be made on objects whose temperature exceeds 100°C at the time of printing.
3. No open fire or spark producing devices or objects are allowed in the area where the device operates.
4. During printing ink drops invisible to people's eye are jetted out of the head at pressure. Do not aim head outlet **2** at any persons, animals or casual objects because they may get splashed with ink unintentionally.
5. The following requirements need to be met when washing, cleaning and maintenance operations are performed or ink containers are replaced:
 - ◆ The operations can only be performed in a workplace that is especially designed for that purpose, when the device is switched off and protective clothing is worn. A fire extinguisher designed to extinguish electrical devices and flammable solvent fires must be placed within easy reach of the device. Air ventilation needs to be ensured at the workplace.
WARNING: The ink is inflammable!
 - ◆ Be careful not to splash the ink. Especially **eyes need protecting**. It is advisable to wear protective glasses.
 - ◆ Protect the ink and the solvent (also waste fluid remaining after the printer has been washed) against fire, high temperature, sparks, electric arc and other electric discharge as they **may cause ignition of these inflammable fluids!**
 - ◆ Do not use plastic vessels to do the washing. Metal vessels are recommended.
6. Protect the printer against dirt, heavy dust and excessive moisture.
7. EBS Ink Jet Systeme is able to ensure perfect and safe operation of the printer only when original, printer-specific accessories and consumables are used.

Laser Radiation Safety

Laser pointer **4** is activated during printing for print positioning. The pointer emits class 2 laser radiation (according to IEC 60825-1) at the wavelength of **650 nm**, with a maximum output power **< 1 mW**. The laser beam is not generated in pulses.

1. Do not direct the laser beam of a radiation emitting laser device toward persons or animals, or stare at the beam. The laser light can damage sight.
2. Do not stare at the beam or look directly through optical instruments (magnifying glasses, magnifiers, microscopes, binoculars, telescopes). The looking through certain optical instruments (e.g. loupes, magnifying glasses and microscopes) at an output laser beam from a distance of up to 100 mm may generate hazard to the eyes.
3. Avoid directing the beam toward the planes that reflect laser radiation well (mirrors or other glossy surfaces) so that the reflected beam(s) does not shine in the eyes.



The printer is marked with the following warning label in English, as standard. The label is put on the left-hand side of the printer on plug 5 covering the hole through which electromagnets can be adjusted.



Labels in several languages come together with the printer. If you prefer a different language than English, replace the label with a more suitable one. If the label is not available in your language, translate the label contents into your language and hand it over to the printer users.

Protecting the Battery Pack

The following principles need to be obeyed to protect the batteries that are built into the printer:

- ◆ Protect the printer against excessive temperature and fire. Do not expose it to strong solar radiation for a longer time.
- ◆ Avoid a sudden change in temperature (cold → hot) that might cause vapor condensation inside the printer and thereby speed up battery discharge and electronic circuit corrosion. Condition the printer for about 1 hour before use after it has been moved from a cool place to a warm one.

When Ink or Wash-up Spills

- ◆ Should the eyes or skin get irritated with ink or wash-up:



EYES rinse the eyes with running water for at least 15 minutes, then see your oculist.

SKIN wash the skin with water and soap.

- ◆ If the clothing has been splashed, take it off as soon as possible.
- ◆ When ink or wash-up spill, wipe out the spilled fluid with a piece of absorbent material, and then remove the material in compliance with fire and health and safety-at-work regulations.

Control of Electromagnetic Interference

1. Properties of high-frequency devices.

Your Ink-Jet printer contains a high-frequency transmitter and receiver. When it is in the ON state, the printer receives and transmits high-frequency (HF) signals.

The controller of the Ink-Jet printer system controls energy emitted during printer operation on an on-going basis.

The HANDJET® EBS-260 printer complies with all the requirements of the regulations concerning the impact of the HF energy on humans in your country – see **Conformity Marking** (p. 11).

2. Printer accessories.

If you do not use original EBS parts or printer accessories, including batteries or electronic components, the statutory requirements may not be met and the HF electromagnetic emission limits may be exceeded.

Impact on Medical Equipment

Pacemaker and Other Medical Implants

The printer contains built-in high-frequency transmitters and receivers. Persons having medical implants should not approach the printer to a distance smaller than 20 cm (8 inches) from the implants not to disturb implant operation.

Other Medical Equipment

If you use a piece of medical equipment, please ask the equipment manufacturer whether the equipment is sufficiently shielded against electromagnetic radiation. In certain circumstances your doctor may help you gain the information you require.

Operation in Explosion Hazard Areas

If you work in an explosion hazard area, switch your Ink-Jet printer off, **do not** replace the batteries or **do not** remove them from the printer and follow all instructions and precautions. Sparking generated by batteries may cause an explosion and/or fire in this hazardous area and result in personal injuries or even death.

The regions where a potential explosion hazard exists are usually marked appropriately. The examples of such regions are: solvent storage areas, fuel storage areas and petrol stations, below-decks onboard ships, storage areas for explosive gases, air mixtures, chemicals and metal or flour powders.

Operation in Areas of Blasting

In order to avoid disturbance during blasting operations, the printer should be switched off in the areas where such operations are performed or where the use of radio equipment is forbidden.

Follow the operating instructions and information signs.

Conformity Marking

The HANDJET® EBS-260 printer has been subjected to the compliance procedure, which has ended with the issue of a Declaration of Conformity. The Declaration gives the grounds for the statement that the HANDJET® EBS-260 printer, together with its dedicated power pack P350097 and other manufacturer equipment, to which this Declaration applies and which shall be installed and used according to the manufacturer's instructions, meet the essential requirements and other relevant provisions of the following directives:

2014/53/EU,
2011/65/EU

and meet the following standards:

Standard	RED Directive reference
EN 60950-1:2006 + A11:2009 + A1:2010 + A2:2013, EN 62479:2010, EN 50364:2018.	The protection of health and safety of persons and of domestic animals and the protection of property - with reference to Art. 3, par. 1 a)
ETSI EN 301 489-1 V2.1.1:2017, ETSI EN 301 489-3 V2.1.1:2019, ETSI EN 301 489-17 V3.1.1:2017	The protection requirements with respect to electromagnetic compatibility - with reference to Art. 3, par. 1 b)
ETSI EN 300 328 V2.1.1:2017, ETSI EN 300 330 V2.1.1:2017.	Effective use and support the efficient use of radio spectrum in order to avoid harmful interference - with reference to Art. 3, par. 2

Therefore the HANDJET® EBS-260 printer bear the mark:



Environmental Protection

After the printer has been put out of service, do not take it out together with other domestic waste.

According to Directive No **2012/19/EU** of the European Council on electrical and electronic equipment waste, the HANDJET® EBS-260 printer and USB-Bluet

ooth modules that have been put out of service must be separated from domestic waste and processed in an environmentally friendly way.



Preparing the Printer for Operation and Setting Basic Parameters

Operating Touch Screen

The main screen of the printer consists of the following elements:

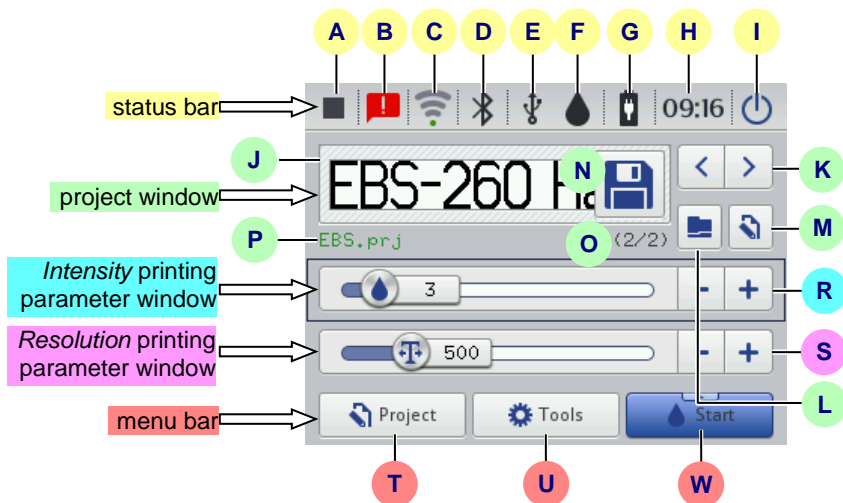

status bar	A	Printing status – see Printing a Project via Printer LCD (p. 119),
	B	Messages containing the information on printer operation (the icon displayed when the messages are available) – see Messages (p. 37),
	C	Status and the settings of WiFi wireless network – see WiFi Wireless Connection (p. 29),
	D	Bluetooth status and settings – see Bluetooth Interface (p. 32),
	E	Pendrive/USB disc status (the icon is not displayed, when the disc is not connected to the printer) – see Connecting USB Disc to the Printer (p. 34),
	F	Ink container status – see Ink Level in Container (p. 20),
	G	Battery status – see Energy Management (p. 25),
	H	The current time of the printer and the date and time settings – see Date and Time Settings (p. 22),
	I	Switch the printer off and then on again, log out the user and disable the screen – see also Switching the Printer Off (p. 16).

project window	J	Preview a project to be printed	
	K	Select projects to be printed, from the same folder	
	L	Open a project to be printed	
	M	Edit a project to be printed and printing parameters of that project	
	N	Save the project parameters modified	If a modification is not saved, the project can be printed with the modified parameter only until a new project is opened or the printer is switched off.
	O	Project number in the folder / the number of projects in the folder	
	P	Project name (if the name is in green, the project is ready for printing)	
print intensity	R	Decrease or increase print intensity	A change in the intensity setting results in a lower or higher saturation of a printout with ink of a given color. You can change the intensity of a printout of a chosen project by pressing the - or + button or by shifting the slider handle. If the parameter setting is modified, press the N button to save the modifications to the project.
print resolution	S	Increase or decrease print resolution	A change in the width of characters printed and the length of the entire project are the visual effects of a modification to the resolution setting. You can change the resolution of a chosen project by pressing the – or + button or by shifting the slider handle. If the parameter setting is modified, press the N button to save the modifications to the project.
menu bar	T	Create a new project and edit an existing project – see Creating a New Project (p. 41) and Opening and Editing a Project (p. 41)	
	U	Set the language, date and time format (General Settings (p. 21)), sound (Sound Settings (p. 23)), energy (Energy Management (p. 25)), users (User Manager (p. 28)), WiFi (WiFi Wireless Connection (p. 29)) and Bluetooth (Bluetooth Interface (p. 32)), service options – see Service (p. 69)	
	W	Enable and disable printing – see Printing a Project via Printer LCD (p. 119), rinse the nozzles – see also Purging (p. 70) and Measure (p. 119)	

EN

Make sure that the edges of the housing are not touched while LCD buttons are being touched on the screen touch – this may disrupt the detection of a touch.

If the touch screen cannot be used (e.g. the operator wears gloves), the keys available on the keypad **10** can be used instead. With the key **24** you can switch over between the project window and printing parameter windows. The active window is framed in black. The keys **25** and **26** are designed for choosing a project and changing the parameter settings.

Simple menu

You can switch between the main screen and the simplified screen by touching the selection button that is by the **Simple menu** option in the General Settings **Common** sheet tab (see **General Settings** p. 21)).

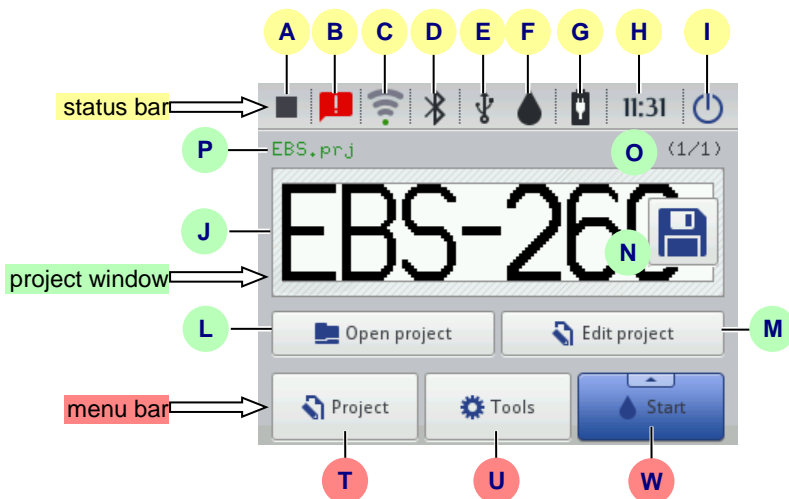





















Use can use the keys **25** and **26** on the keypad **10** to choose a project for printing (within one folder).

LCD Keypad

The on-screen keypad can be used for changing the settings of parameter and inputting text files from the printer touch screen (LCD) level. It is displayed on the LCD display after a given parameter field has been chosen, while the password is being typed in during logging in operation or while a text is being input to a project.



The keypad contains a full set of Latin letters and a set of digits; moreover it also contains special buttons:

-     – to move the cursor (  are available for the keypads that are displayed while multiple-line text objects are being edited),
-  – to shift between small letters to capital letters and the other way round,
-  – to shift between letters and punctuation marks and digits and the other way round,
-  – to convert the Latin letters into Chinese characters (mode of input: pinyin) and the other way round (the button is available after the  button has been touched),
-  – to convert the Latin letters into Cyrillic letters and the other way round (the button is available after the  button has been touched),
-  – to convert letters into special symbols and the other way round,
-  – ENTER – to move to the following line,
-  – to delete the character that is on the left of the cursor,
-  – to delete an entire text (to clear the edit field),
-  – to undo deletion (the button is available after the  button has been touched),
-  – to move back to the previous display,
-  – to confirm that you want to input a text you have typed in (the button is available after you have started typing in),
-  – to abandon inputting a text (the button is available after you have started typing in).

Moreover, diacritical characters are hidden under certain buttons (the are available after a given button has been touched and held on). These buttons include:

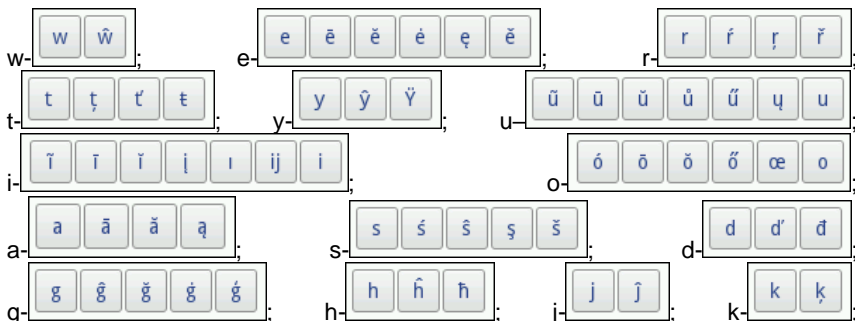



Switching the Printer On and Off

See figure **A**.

Switching the Printer On



Touch button **18** (and hold it on for about 1s) on the printer keypad **10**. The switching on is done properly when diode **19** emits lights and an audible signal is heard from buzzer **34** (🔊). The printer is ready for operation when the main screen is displayed (in about 30 s from the switching on).





When the printer is switched on, you can move to print a text file from printer memory.

Switching the Printer Off

The printer can be switched off in three ways:



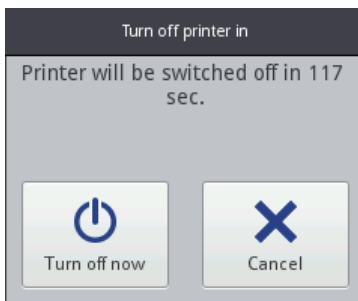

- ◆ by means of button **18** on the printer keypad **10**,
- ◆ by means of the  (I) button on the printer touch screen **12**,
- ◆ remotely, with *EBS Web User Interface* available via a Web Browser, by means of the  button.

When you press button **18**, the display shows the message that the printer will be switched off in 120 seconds. You can speed up this operation by touching

the  button or cancel it by touching the  button.



When the  (I) button is touched, the window containing the following options is displayed on the printer touch screen and also in *EBS Web User Interface*:

- 
 – to switch off promptly after the button is touched,
- 
 – to switch off and restart the printer,
- 
 – to log out the current user and display the log in display – see [Logging In](#) (p. 18),
- 
 – to enable the screen lock (this option is available only on the printer screen) – see [Display Parameters Settings](#) (p. 27).

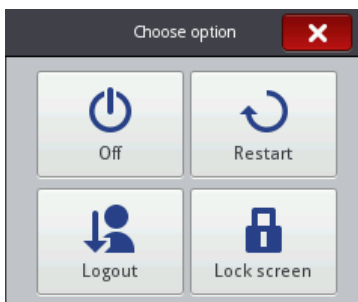

The switching off is done properly, when diode **19** goes out and screen **12** switches off. It can also be signaled with an audible signal (see [Sound Settings](#) (p. 23)).

The printer can be switched off automatically after a period of inactivity – see [Display Parameters Settings](#) (p. 27).

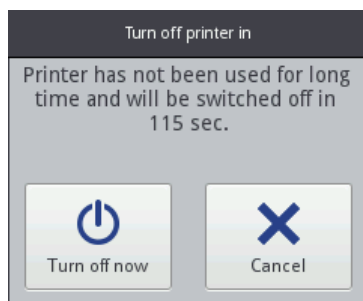

Shutting the Printer Down in Emergency Shutdown Mode

In an emergency situation, when the above mentioned ways of printer switch off turn out ineffective or when the printer needs to be switched off immediately, you can do that in two ways:

- ◆ by holding button **18** on keypad **10** over a minimum of 4 second or
- ◆ by touching button **18** and holding it together with trigger **6** at the same time.

After emergency switch off the settings of the printer counters and unsaved projects are lost. If the emergency switch off occurs too frequently, it may lead to printer damage (e.g. damage to the file system).

Logging In

You can be logged in automatically as Administrator by default (the default password is **1**). You can disable automatic logging in or change the default account - see [User Manager](#) (p. **28**).



If the current user is logged out with the [Logout](#) button (see [Switching the Printer Off](#) (p. **16**)), a list of user is displayed on the printer screen. After a user name has been chosen, a keypad is displayed (see [LCD](#) (p. **14**)) with which to type in the password.

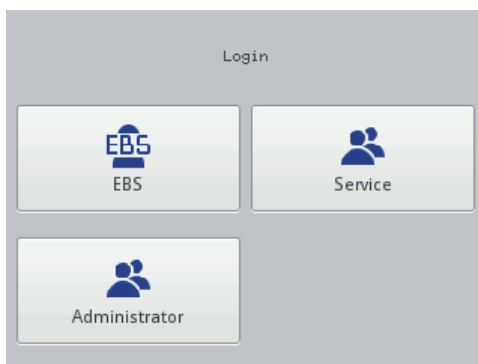

Installing and Replacing Ink Container

See figure **C**.

Installing Ink Container in the Printer

Every ink container is equipped with a transponder that stores the information on the type of ink and its date of manufacture. The printer has a built-in circuit that scans the data from the transponder and thereby it helps check whether the ink used is of the proper quality. The detailed information on ink (the container fill-in level, the ink color, the type of solvent, the type of dye, the expiration date for the ink, the date when the container has been accepted) is available after the drop-shape icon on the main display top bar has been touched.

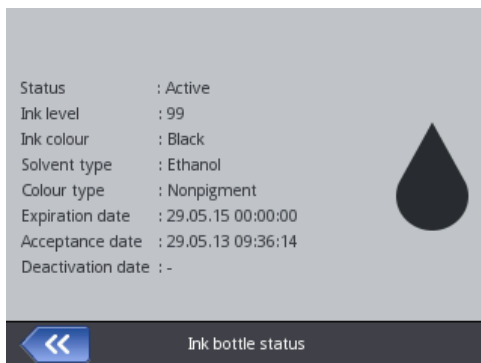

When the printer is delivered, the ink container is detached. Follow the steps below in order to install the container:

1. Remove the container from packing **13**.
2. Position the container **13** relative to the back part of the printer so that the triangular mark on the container is directly opposite the printer middle line **27** and that the printer's pin goes into the container's non-return valve opening.
3. Press the container against the printer and turn it clockwise by 270 degrees.

When a new container is accepted, the following message is displayed: **(I99000) New ink container successfully accepted.**







Should problems with the acceptance of an appropriate and correct container occur, the service staff can make temporary acceptance of such a container possible (for 50 hours) – see **Unlocking Options** (p. **71**). The information on such a temporarily

accepted container appears in the form of the  icon (**F**) on the status bar.



Ink Level in Container

When the printer stops printing, make sure that it is because the ink container has been emptied. The level of ink in the container is displayed on screen **12**

with the  icon (**F**):

					
0%	1–9%	10–30%	31–60%	61–80%	81–100%

In addition, the  and  icons displayed alternatively can indicate that:

- There is no ink container in the printer,
- There is a problem with ink, e.g. the ink is past its use-by date, or the print limit assigned to the printer has been exceeded. The information about the problem is displayed after the  icon (**F**) has been touched, and also in message form after the  message icon (**B**) has been touched.
- There is no communication with the container controller – restart the printer, and when the problem does not subside, contact your service point.

Replacing Ink Container

If possible, replace the container in dustfree conditions so as to minimise the amount of contaminants getting in to the printer's ink system.



Do not leave the printer with the ink container detached for a longer time than that required to replace the container. While detaching or installing the container be careful not to splash anyone or anything with the ink that may flow out of needle **32**.

1. Turn the printer off - see **Switching the Printer Off** (p. 16).
2. Put the printer in such a way that the container points downwards, turn empty container **13** to the left (**a**). Wait about 3 seconds while holding the container to equalize the pressure.
3. Remove the container carefully (**b**).

See figure **C**.

4. If gasket **33** is dirty, remove ink leftovers from it with wash-up.
5. Install a new container - see **Installing Ink Container in the Printer** (p. 19).

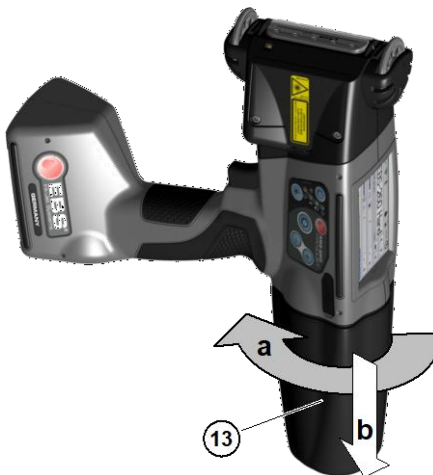

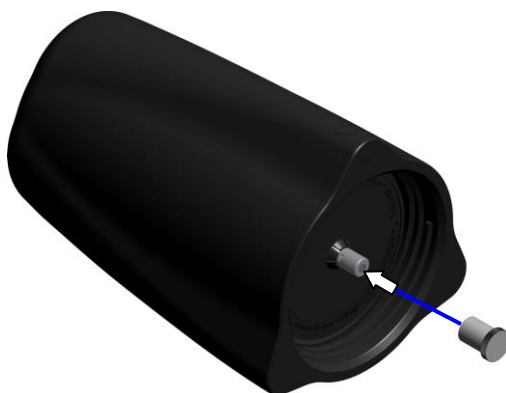

Ink may flow out of a worn out container. Secure the container valve with transport cap **31** that you can take from a new container, in order to avoid spontaneous outflow of the ink.

General Settings

The general settings are accessible by touching the following buttons in turn: **Tools (U)**, **Settings** and **General**.

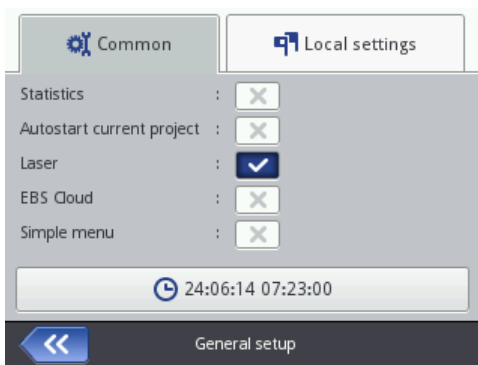

In the **Common** sheet tab you can:

- ◆ Change the settings concerning the generation of **Statistics**. You can collect the data on the number of prints made for each of the projects. The report is available in the printer after the **Tools (U)** and **Statistics** buttons have been touched as well as in *EBS Web User Interface* in the **Info** menu – see **Operating Statistics** (p. 117).
- ◆ Enable/disable the **Autostart current project** option – after the printer has been switched on, the recently printed project is read-in automatically, and the printer moves to the **Print on (waiting)** state. Press the trigger and move the printer along an article to be labeled in order to start printing.
- ◆ Switch on/off the **Laser**, which is used for indicating the lowest nozzle position. It is helpful in positioning the printer on the surface to be labeled. The laser is on from the moment the project is enabled for printing and the print release button is pressed until the printing of a given print is finished.
- ◆ Switch on/off **EBS Cloud**, a tool that enables you to maintain and monitor the state of the printer remotely.
- ◆ Switch to the simplified menu – see **Simple menu** (p. 14).
- ◆ Re-set the printer date and time settings by touching the  button – see **Date and Time Settings** (p. 22).



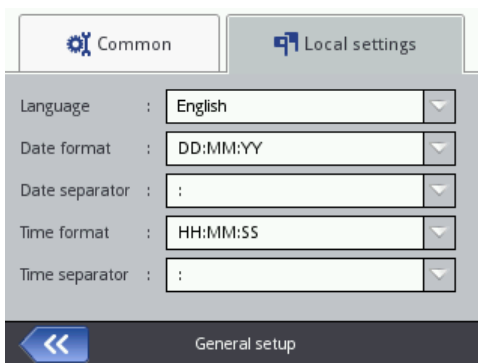



In the **Local settings** sheet tab you can change the interface **Language** (after a new language setting has been confirmed, the interface software on the LCD starts running again within 10 seconds), date and time format (the sequence and the number of date and time components), and also change separators between the date and time components as default formats for newly created **Date/Time**-type text objects.





Confirm the modified parameter settings with the  button or abandon them with the  button. If no modifications have been made, you can go back to the previous screen by touching the  button.

Date and Time Settings

The date and time are accessible for modification by touching time **H** displayed on the top bar of main screen **12**. Modifications can be made with the ,  buttons or by typing in a setting via the keypad. Confirm the modification with the  button or abandon it with the  button. If no modifications have been made, you can return to the previous screen by touching the  button.



The date and time themselves and their formats in the general settings menu – see **General Settings** (p. 21).

The modified parameter settings should be confirmed with the  button or abandoned with the  button. If no modifications have been made, you can go back to the previous screen by touching the  button.

The date and time settings can also be modified with *EBS Web User Interface* – see **General Settings** (p. 113).

Sound Settings

The sound settings are accessible by touching the following buttons in turn: **Tools (U)**, **Settings** and **Sound**.

In the **General** sheet tab you can set **Error sound signal**, **Keyboard audio feedback**, **Touchscreen audio feedback**. If the **Enable sound** check box is unticked, the sound is silenced completely, irrespective of what the settings of the other options are.

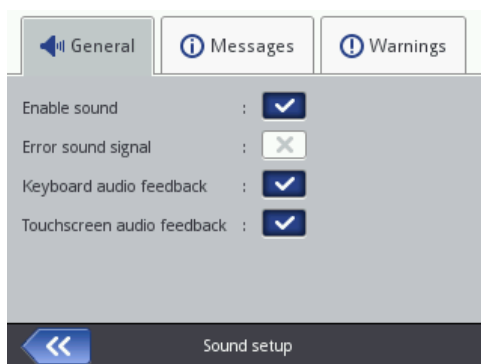



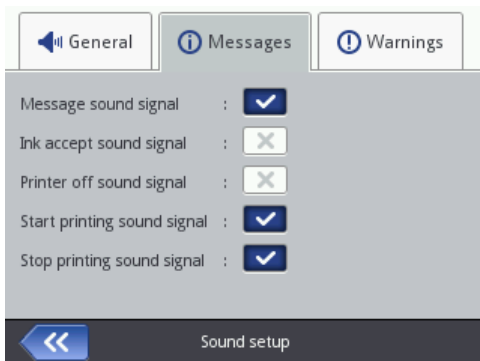

In the **Messages** sheet tab you can modify the sound settings for starting and stopping printing (**Start printing sound signal** and **Stop printing sound signal**), accepting an ink container

(**Ink accept sound signal**), and also for switching the printer off (**Printer off sound signal**). If the **Message sound signal** check box is unticked, the sound that goes with every message is disabled:

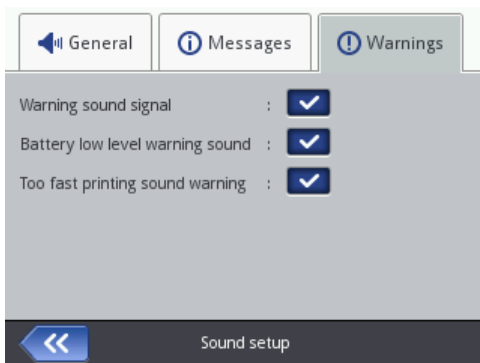

In the **Warnings** sheet tab you can modify the sound settings for the following warnings: low battery level (**Battery low level warning sound**) and too fast printing (**Too fast printing sound warning**). If the **Warning sound signal** check box is unticked, the sound that goes with every warning is disabled.



The modified parameter settings should be confirmed with the  button or abandoned with the  button. If no modifications have been made, you can go back to the previous screen by touching the  button.

Energy Management

The detailed information on the batteries (the battery status, voltage, current, charge level, temperature) is available after the battery icon on the main display top bar has been touched.

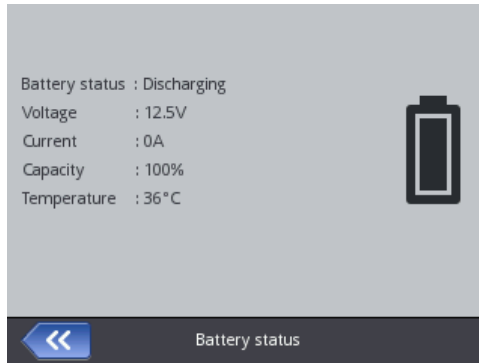

EN

Charging the Battery



The HANDJET® EBS-260 printer is not equipped with a disconnecter (a power switch), therefore an AC power socket should be easily accessible for connecting the printer to get the battery recharged.

A LI-ION top-quality battery has been installed in the printer. It can be recharged at any stage of printer operation.

The battery that is new or has not been used for a long time cannot be charged up to its full capacity. Therefore, in order to form the battery follow three charge-

and-then-discharge cycles. See figures **A** and **B**.







1. Pull out plug **16** from socket **15** and tilt it.
2. Insert power pack connector **29** to socket **15** and the outlet plug of the power pack **28** to a wall outlet.
3. When the battery is in the process of being recharged, diode **20** flickers, and the battery-and-lightning-bolt icon appears on printer screen **12**. Wait until the recharging finishes, which is signaled with continuous light emitted



by diode **20** and the  icon (**G**) displayed on screen **12**. Do not turn the mains electricity off or remove the power pack connector from socket **15** while recharging is in progress.

4. Remove power pack plug **29** and secure socket **15** with plug **16**. Detach the power pack from the mains and place it into the bag.
5. In order to maintain battery efficiency for a long time, the battery should not be recharged until it is discharged completely – see **Low-battery Indicator** (p. **26**).

Recharging indicators:

					
0-4%	5-24%	25-49%	50-74%	75-99%	99-100%
diode 20 flickers 4 x per second	diode 20 flickers 2 x per second		diode 20 flickers every 1s		diode 20 emits cont. light

The HANDJET® EBS-260 printer should be stored with its batteries charged. If the printer is to be stored for a longer time (6 months or longer) and its batteries are not recharged, it may work for a shorter time after it has been recharged afterwards or in certain circumstances even stop working. Such a phenomena is caused by the properties of the batteries, which are always subject to the process of self-discharging. In the consequence of self-discharging and long-term storage in the discharge state, the maximum capacity of the batteries may lower or the batteries may get damaged completely.

In order to avoid such a situation, it is necessary to charge batteries of the HANDJET® EBS-260 printer at least **twice a year (however not less frequently than every 6 months)**. Otherwise, the printer may stop working or the printer operation time after recharging may shorten dramatically.





The battery is not replaceable as standard.

Low-battery Indicator



The printer indicates a low-battery condition with a buzzing signal from buzzer **34**  (provided that an appropriate alarm has been set – see **Sound Settings**

(p. 23)) and the  icon (**G**) displayed on screen **12**. An extreme discharge condition (below 5%) is signaled with a very fast, uniform flicker of diode **20** and

the  icon (**G**) displayed on screen **12**. When the battery reaches its critical condition, any further use of the printer is interrupted and the printer switches off automatically. The battery should be recharged.

If the  icon (**G**) is additionally displayed, this may mean that there is no communication with the battery controller or that the battery is damaged – when such an icon is displayed, restart the printer; when the problem does not subside, contact your service point.

Display Parameters Settings

You can save the energy of printer batteries by making appropriate settings for display parameters. Touch the following buttons in turn: **Tools (U)**, **Settings** and **Power**.

On screen displayed you can do the following:

- ◆ Set **Normal screen brightness**,
- ◆ Blank the screen after a time with the **Turn off screen after** command,
- ◆ Dim the screen after a time with the **Dim screen after** command,
- ◆ Modify the setting of the **Dimmed screen brightness** parameter,
- ◆ Allow the screen to be locked with the **Enable screen lock** command,
- ◆ Set the time after which the printer switches off automatically, with the **Printer turn off time** parameter (the time is counted from the moment when screen **12**, keypad **10** or trigger **6**) is last touched.

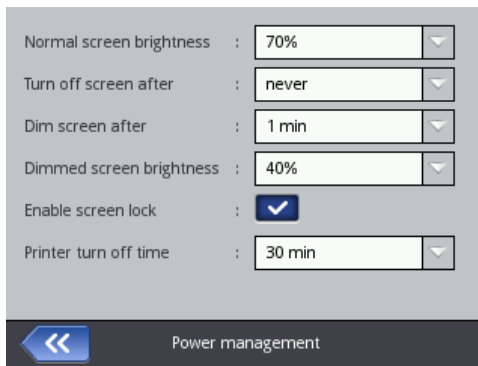

EN



The screen lock can be enabled when the setting of the **Turn off screen after** parameter is different than **never**. In addition, when the **Dim screen after** parameter is enabled, the screen locks after the sum of both of the times, **Dim screen after** and **Printer turn off time**, expires. The screen lock can be disabled after the two buttons (1 and 2) displayed are touched quickly. The screen lock can be enabled at any time by holding button **24** or by touching the

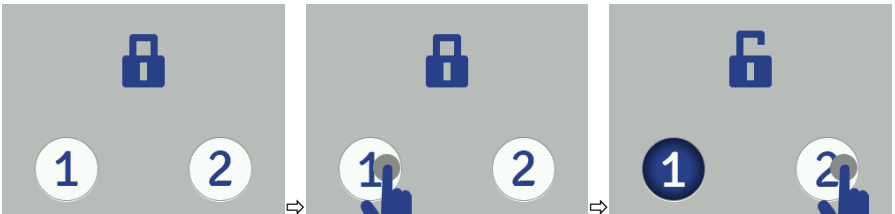

 (I) and  buttons.





The modified parameter settings should be confirmed with the  button or abandoned with the  button. If no modifications have been made, you can go back to the previous screen by touching the  button.



User Manager

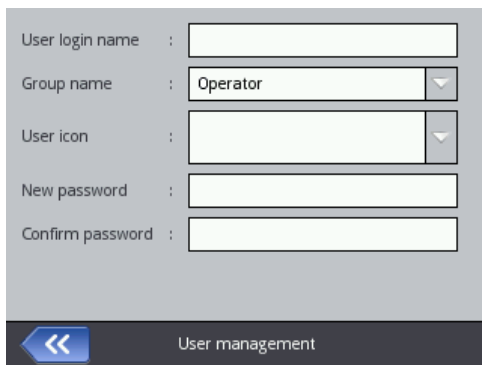

The printer can be used by a few users; each of them have different authorizations. Touch the **Tools (U)**, **Setup** and **Users** buttons in turn to open User Manager.

Touch the  button to add a new user. In the window displayed fill in the **User login name**, **New password**, **Confirm password** fields, and also choose the group to which the new user is to be assigned. You can also choose an icon for identifying the user (the icon must saved in printer memory in advance – see **Image Manager** (p. 106)). The modified parameter settings should be confirmed with the  button.



Highlight the name of a user in the user list and touch the  button in order to edit the user data. The modified data should be confirmed with the  button.

Highlight the name of a user in the user list and touch the  button in order to remove the user. The user removal operation should be confirmed with the  button on the screen.

If a user is marked with  (by touching the  button after the user has been highlighted), this user will be logged in automatically after the printer has been switched on. Administrator is marked with , by default.

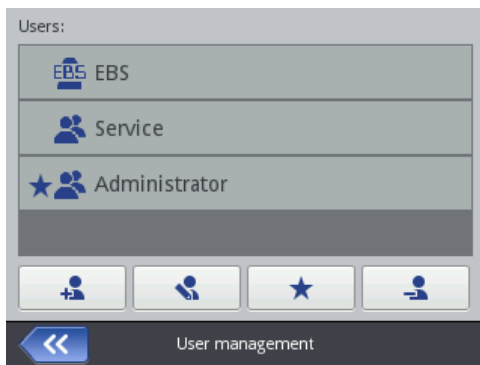

The User Manager is also available via a Web Browser – see [Tools – Users Manager](#) (p. 109).

Touch the  button to return to the previous screen.

Radio Communication among the Printer, a Computer and External Devices

WiFi Wireless Connection

You can use WiFi for communicating the printer with a computer.

The WiFi parameter settings are accessible in two ways:

- ◆ By touching the  icon (C) on the status bar of main screen 12, or
- ◆ By touching the **Tools (U)**, **Settings** and **WiFi** buttons in turn.

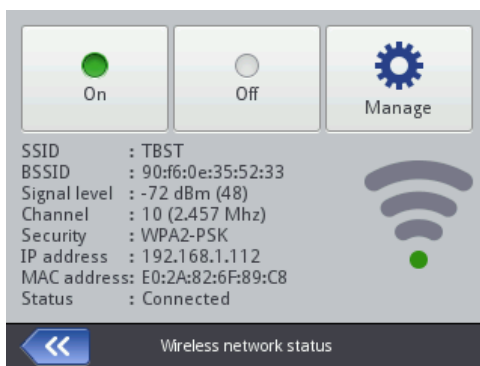

The display shows the parameters of the network into which the printer is linked. You can use the buttons available for activating and deactivating the network, and also to scan the environment in search for a new network. When the printer is linked into a given network via WiFi, then diode 21 emits orange light.



A signal strength icon is displayed in the top left corner of main screen 12.

Connecting the Printer to a New Network via WiFi



1. Move to the WiFi parameter setting window and touch the  button. A list of the networks available is displayed, together with the information whether a given network is secured (🔒) or not.
2. Choose the network you wish to link to in the list and touch the  button.

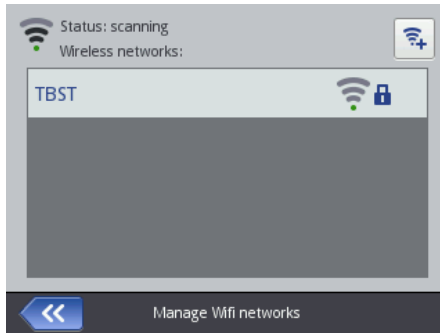

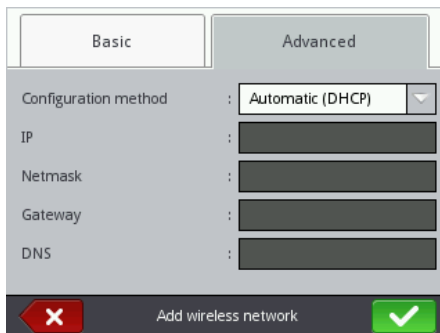
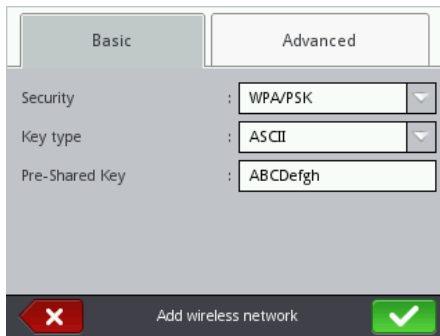

3. Type in the network data in the **Basic** and **Advanced** sheet tabs. Confirm the modifications with the  button.

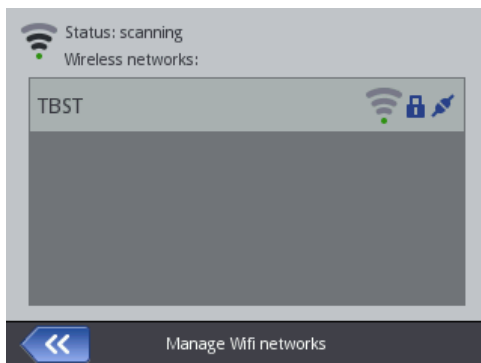

4. The successful connection with the selected network is confirmed with the  icon that is displayed by the network name.



EN

5. If you wish to modify the settings of a WiFi network, highlight the network in the list and touch the  button. The **Basic** sheet tab contains the parameter called **Do not connect to this network**. The parameter is useful when there are several networks with a similar signal strength in the list (the printer might switch among the networks then). If the check box of that parameter is ticked, no connection to a given network is made automatically. Confirm the modification to the data with the  button. You can delete the configuration data for a given WiFi network with the  button.

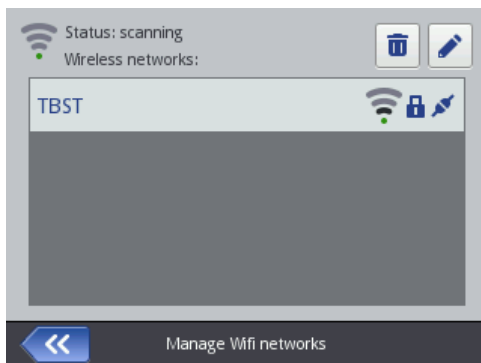

A WiFi status icon is displayed in the left top corner of main screen **12**:



– connection via WiFi is available (the number of black arcs shows the signal strength),

– unknown WiFi status or an error,



– WiFi disconnected.

Confirm the modification to the parameters with the  button.

Bluetooth Interface

You can use Bluetooth technology to communicate the printer with an external device from which data for printing comes (e.g. automatic scales, a barcode reader, etc.).

The Bluetooth parameter settings are accessible in two ways:

- By touching the  icon (D) on the status bar of main screen 12, or
- By touching the **Tools (U)**, **Settings** and **Bluetooth** buttons in turn.

The display shows the state, name and address of the Bluetooth module of the printer. The Bluetooth name can be modified by touching the white box where the name is given. If the printer is connected with an external device, the address of that device is also displayed. With the buttons available you can switch the Bluetooth module on and off and also move to the device search display (Bluetooth must be active before you start doing that).

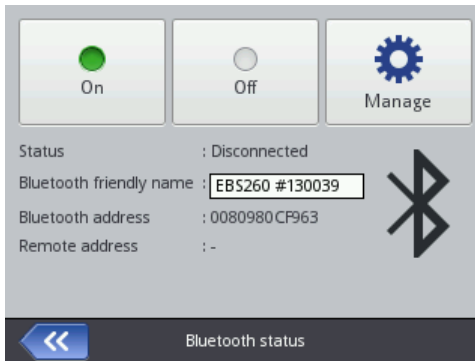

A Bluetooth status icon is displayed in the top left-hand corner of main screen 12:



– Bluetooth active



– Bluetooth inactive



– the printer is connected with an external device.

Establishing Connection between Printer and External Device

1. Move to the Bluetooth parameter settings, activate Bluetooth (with the



button) and touch the



button.

Touch the  button on the screen displayed in order to find new devices. The external devices available are shown in the list.

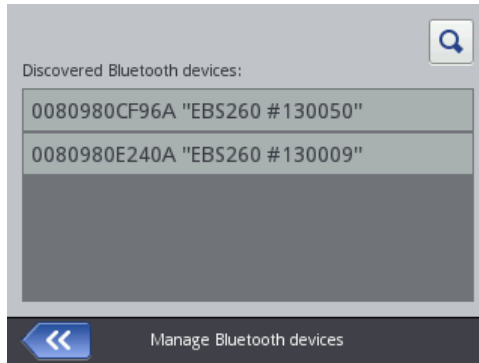

EN

2. Choose a device you wish to connect to in the list and touch the  button.



3. When the connection to the chosen device is made successfully, the



button is displayed on the Bluetooth settings screen, so is the  icon on the status bar, and diode 21 emits blue light.

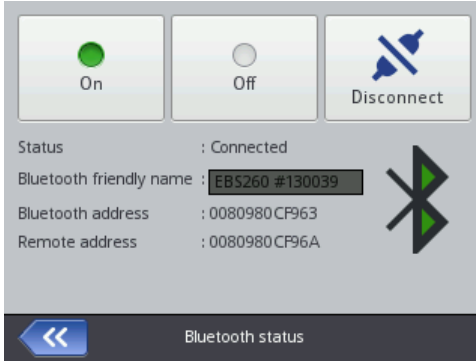

Touch the  button in order to finish the connection.

Connecting USB Disc to the Printer

If you connect a disc to the printer via USB port 9, you can import and export files and update printer software.

The USB disc must be formatted in the FAT or FAT32 file system.

The USB disc tools are accessible in two ways:



- By touching icon **E** on the status bar of the main screen (the icon is displayed when a disc is connected to the printer), or
- By touching the **Tools (U)**, **Service** and **USB** buttons in turn:



Importing Projects

With the project import function you can download projects made with *Offline EBS Web User Interface* or created in another printer to the printer.



Touch the  button. Choose a file with the extension EXP in the file list on the screen displayed or touch the text field and type in the name of a file via the keypad displayed, and then confirm with the  button. On choosing the file or typing in its name, confirm the selection with the  button. When the file is imported successfully, the following message is displayed:

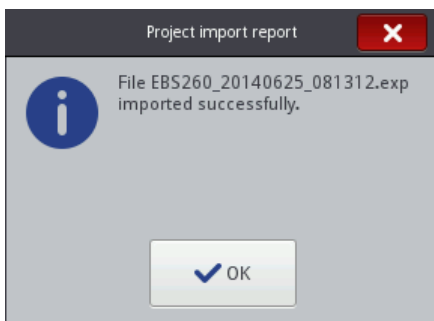

Exporting Projects

With the export project function you can save the projects that are in printer memory in order to use them in another printer and make a backup copy.



NOTE! It is recommended that backup copies are made regularly to protect the data against loss.

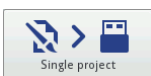
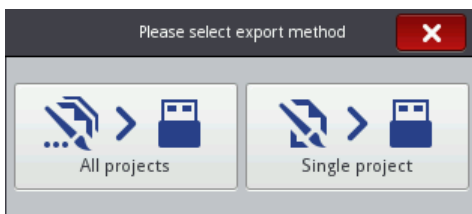

Touch the  button. Choose a mode of export on the screen displayed: **All projects** or **Single project**.

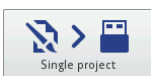

Touch the  button to export a single file. On the screen displayed choose a file with the extension PRJ in the list or touch the text field at the top of the screen and type in the mane of a file via the keypad displayed and confirm

with the  button. On selecting the file or typing in its name, confirm the selection with the  button.

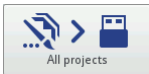

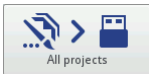
Touch the  button in order to export all projects. If a single project or all projects are exported successfully, the following message is displayed:

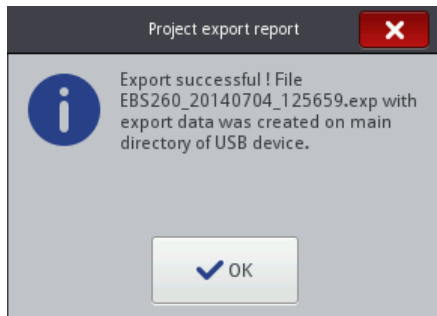

Updating Software

Owing to software updates, the printer always has up-to-date and improved software, which makes it function better.

New versions of the software are stored at <https://handjet.com/download/> in the Information Materials sheet tab. The update may involve a loss of projects and user-specific settings, and also the deletion of fonts and images installed. Make sure that the projects and files you wish to save have been backed up before updating – see **Exporting Projects** (p. 35) via the printer (only projects are exported) or **Export Project** (p. 79) via *EBS Web User Interface* (projects and images are exported).



Touch the  button. On the screen displayed choose an update file with



the extension EBS in the list. On selecting the file, touch the  button.



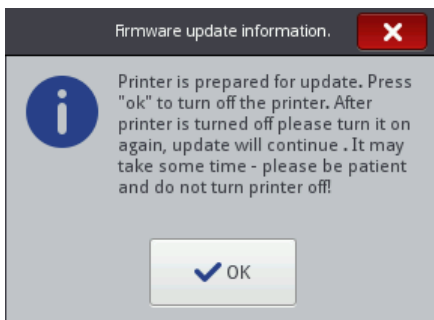

Wait until the printer switches off and then switch it on again and wait until the updating finishes. The following report is displayed when the software is updated successfully:

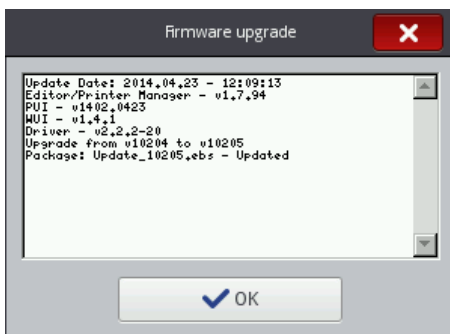

Messages

Important information about printer operation is signaled with the  icon (B) displayed on the status bar (the color of the icon indicates the type of message) and the following window shown in the printer screen:

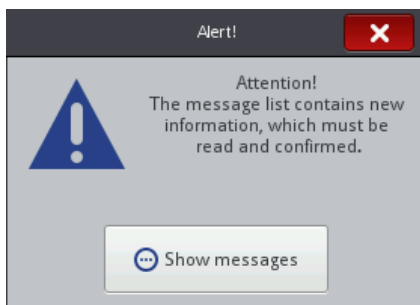



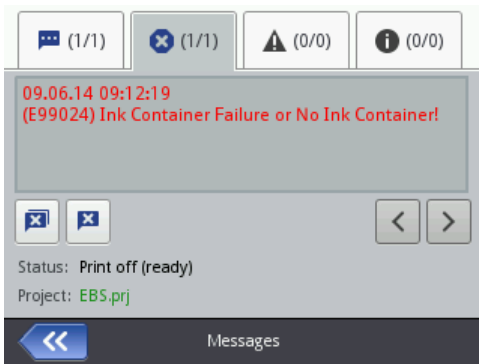



A list of messages is displayed after the  button has been touched.



The message list can also be displayed by touching the **Tools (U)** and **Messages** buttons in turn.

The list is divided into four sheet tabs:

- All messages ,
- Error messages  (the messages are displayed in red, and the  icon is shown on the status bar),
- Warning messages  (the messages are displayed in yellow, and the  icon is shown on the status bar),
- Info messages  (the messages are displayed in blue, and the  icon is shown on the status bar).

The following buttons are designed for use in order to view and delete messages:



– to display the previous message,



– to display the following message,



– to delete a single message,



– to delete all messages.

If there are no messages at any time, the view buttons are inactive.

Statistics

The statistics are accessible after the **Tools (U)** and **Statistics** buttons are touched in turn.

On the screen displayed, in the **Basic** sheet tab you can view the data on the number of hours the printer has run (work time) and on the number of prints made, presented in a user report and a service report (general statistics). Every report is updated after printing has been disabled (see **Printing a Project** (p. 119)) and the statistics window re-opened.



	Worktime	Printouts
User	25.75h	0
Service	45.95h	14

Exploitation statistics

The user report is generated for all users generally. If you wish to obtain a separate report for a given user, clear the statistics at the beginning of work.



For that purpose, go to the **Clear** sheet tab and touch the button.

The general statistics (service report) can be deleted by a Service-type user.



Getting Started

Projects for printing can be created and edited in two ways: via the touch screen of the printer and with a processor that is available via a Web Browser.

Operating the Printer via Printer Touch Screen

EN File Manager

File Manager is available after **Create project**, **Edit project** have been touched (they are accessible with the **Project** button (T)) or after the  open-project-for-printing button (L) accessible on the main screen has been touched. Touch the  button to move to the File Manager. In the newly displayed screen you can manage files and directories. Touch the  button in order to create a new folder. Type in a name of the new folder on the screen displayed and confirm with the  button.

Highlight a file or folder name in the list and then touch the  button, in order to delete the file or folder. Highlight a file or folder name in the list, and then touch the  button in order to change the name of the file or folder.

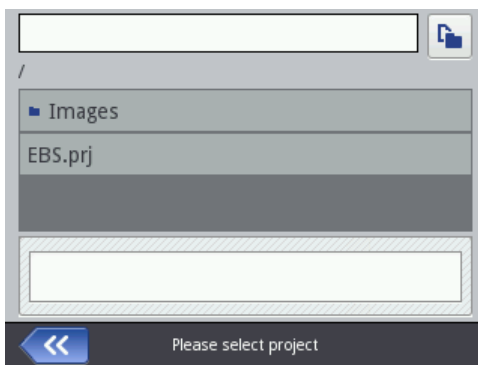

You can copy files and move them among folders with the  copy button and the  move button. Touch the  button in order to close the File Manager and return to the previous screen.

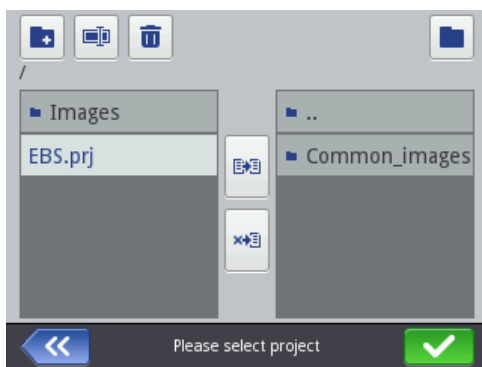





Creating a New Project

Touch the **Project** button (T) and then **Create project**.

On the screen displayed, touch the white box at the top of the screen, type in a name via the keypad displayed and confirm it with the  button. In the following screen confirm the creation of the project with the  button.

Opening and Editing a Project

Touch the **Project** button (T) and then **Edit project**.

On the screen displayed, choose a project in the list or touch the white box at the top of the screen, type in the name of a project via the keypad displayed and confirm it with the  button. In the following screen confirm the opening of the project (for editing) with the  button.

If an attempt is made to open a project, when a project is already opened in *EBS Web User Interface*, the following message is displayed:

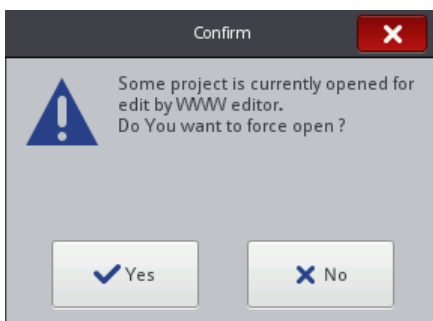

The project opened in *EBS Web User Interface* must be saved before any project is opened on the printer. If you do not do that, the project is closed unsaved and any modification to it are lost.

If you wish to continue editing the project that is opened in *WUI*, touch the **Project** button (T) and then **Continue edition**.

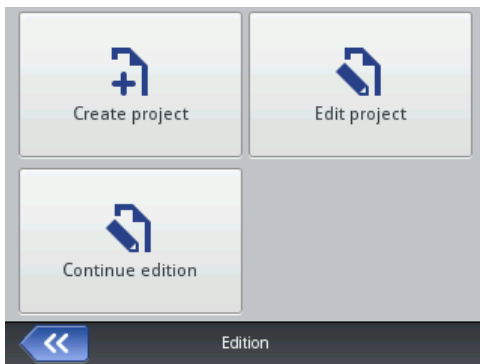

Project Processor

The processor installed on the printer allows you to modify a project from the LCD panel of the printer without any use of a PC.

The edit window is divided into 4 parts:

- ◆ Top bar with tool icons,
- ◆ Edit area (gray), inside which a project is displayed (white),
- ◆ Bottom bar with tool icons,
- ◆ Footnote, where there is the name of a project to be edited and the button designed for closing the processor:



– to save the project currently edited and exit the processor,



– to exit the processor without saving the project,



– to return to the previous screen when no modifications have been made.



The processor footnote shows the project name, whose color changes after the project has been modified (from gray to yellow). When the project is saved, the color of the name changes back to gray.

Part of the buttons can be disabled if a given function is not available for a given type or state of object. When a button is active, the corresponding option is available.

The meaning of the buttons:



– to save a project,



– to set a width of the edit area and printing parameters,



– to open the list objects/clipboard/trash,



– to copy objects to the clipboard (the button is active after an object has been highlighted),



– to paste the object (the button is active after an object has been copied to the clipboard and no object is highlighted),



– to magnify the project inside the edit area,



– to decrease the project inside the edit area,



– to change the initial setting of a counter,



– to add a new object,



– to modify the parameters of an object highlighted,



– to delete the highlighted object,





– to reposition the highlighted object,



– to resize the highlighted object.

Project Properties

The Project Properties window is displayed with the  button. With this tool you can set the width of the working area precisely. The setting can be given as a number of pixels (**px**) or centimeters (**cm**), and the unit needs to be chosen.

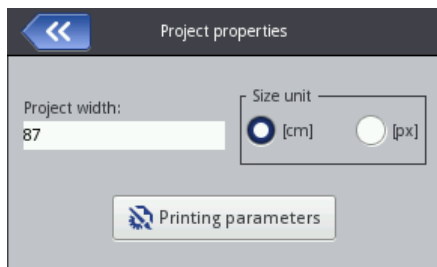

Any modified setting needs to be confirmed with the  button.

You can also move to set the printing parameters with the  button – see [Printing Parameters](#) (p. 65).



List of Objects



The list of all objects used for a project is accessible with the  button. The following operations can be performed on objects in the list:

- ◆ a highlighted object can be deleted with the  button – the deleted object is moved to the trash – see [Trash](#) (p. 45),
- ◆ a highlighted object can be copied with the  button – the copied object is moved to the clipboard – see [Clipboard](#) (p. 44),
- ◆ a highlighted object can be edited; when the  button is touched, the object parameter window opens.





Clipboard

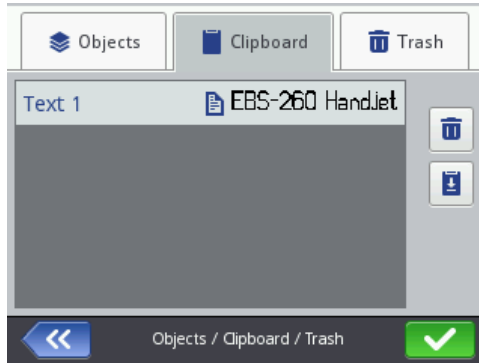

The **Clipboard** is accessible with the  button (the button is available when an object is copied to the clipboard and no object is highlighted). The following operations can be performed on objects in the clipboard:

- ◆ a highlighted object can be deleted from the clipboard with the  button,
- ◆ a highlighted object can be pasted from the clipboard to a project with the  button.



Trash

The **Trash** is accessible by touching the  object-list button or the  clipboard button and by switching to the **Trash** sheet tab. The following operations can be performed on trash objects:

- ◆ a highlighted object can be deleted from the trash with the  button,
- ◆ a highlighted object can be restored into the list of objects with the  button,



Objects



In order to add a new object to a project, touch the  button and then choose an appropriate object on the screen displayed. Objects are grouped in sheet tabs by type: **Text** (text objects), **Shapes** and **Other**.

EN

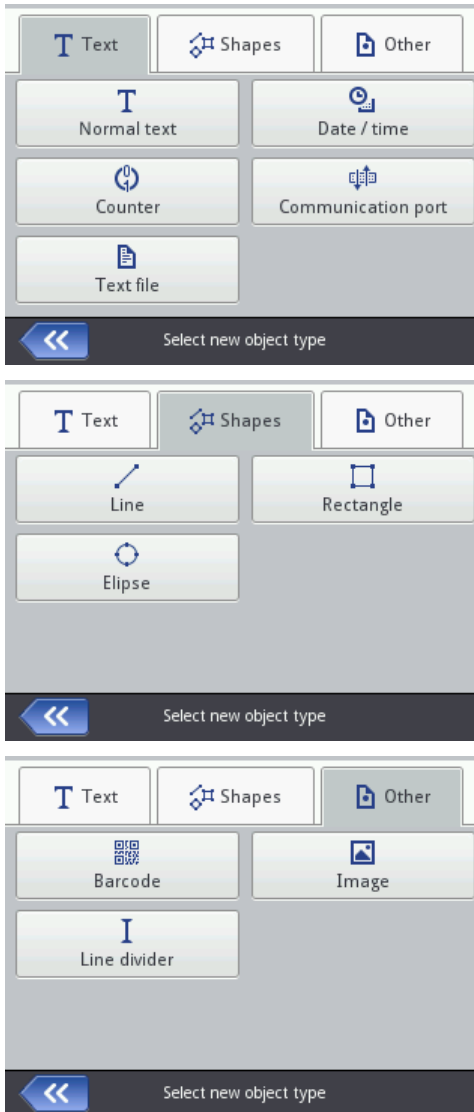



When you choose an object, the object parameter window is displayed so that the parameters could be modified.

You can use the cursor to choose (highlight) the object whose parameters you wish to modify within the edit area. The appearance of a red setting-out frame around the object is tantamount to choosing an object.



Touch the  button to modify the parameters of a given object. The window displayed as the result contains the parameters that are specific for a given type of object and whose settings can be modified. If a new setting is of a wrong type or out of the permissible range, the text field is highlighted in red. Amend the setting accordingly.

Save the project with the  button. The project is saved with the name that was given to it when it was created or it had when it was opened. The button is disabled when the project is already saved or when no modifications have been made. If the project is not saved, the  button is enabled; in addition, the project name displayed at the top of the processor window is red (after saving it changes the color to white).



A project can also be saved with another name by means of the  button.

You can exit the processor with the  button. In this way you abandon editing and the project is not saved.

Repositioning an Object

Highlight an object in the edit area in order to change its position (a red setting-







out frame appears), and then touch the  button – the setting-out frame changes its color to green.

You can reposition an object in two ways:

- ◆ by touching the screen anywhere in the edit area. The point of touch defines the position of the top left-hand corner of an object (the entire object framed in green is moved in relation to the given point).



- ◆ By means of the , , ,  buttons. The object is moved by 1 pixel with every touch.

The object is shifted provided that the project area is greater than the object to be relocated.



Confirm the change in position with the  button or abandon the change

with the  button.









Re-sizing an Object

In the edit area, highlight an object whose size you wish to change (a red



setting out frame occurs), and then touch the  button – the setting-out frame changes color to violet.

You can change the size of an object in two ways:

- ◆ By touching the screen below and on the right of the fixed, top left-hand corner of the object. The indicated point defines the position of the bottom right-hand corner.

- ◆ By means of the  and  buttons (to shift the top edge of the object), the  and  buttons (to shift the bottom edge of the object), the  and  (to shift the left-hand edge of the object) as well as the  and  buttons (to shift the right-hand edge of the object).

The object is magnified provided that the project area is greater than the object whose size is changed.

Touch the  button in order to confirm the change in size or the  button in order to abandon the change.

NOTE! The **Normal text**, **Counter** and **Date/Time** objects can be resized only when the **Scaling** parameter is different then **Fit frame to content**; otherwise the size of the object does not change. The size of a text can be changed with the **Font size** parameter (for True Type fonts) or by changing the type of font (for EBS built-in fonts).

Common Parameters of Objects





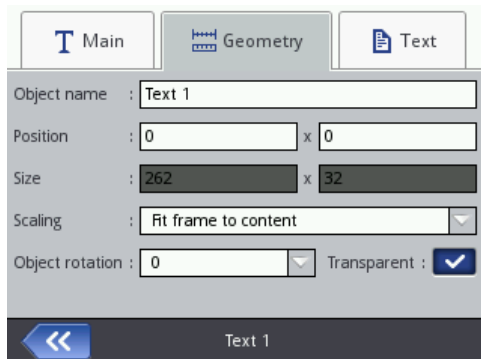

The following object parameters are available in the **Geometry** sheet tab:

- ◆ **Object name**. The type of object is used as the object name, as standard (e.g. Counter 1, Image 2). You can name objects at your choice to facilitate identification, but the same names must not be used, i.e. they must be unique within one project. If you use a name that has already been used within the project, an error is reported when you try to save the parameters of the object named so.
- ◆ The **Position** parameter shows the coordinates of the top left-hand corner of the object frame. You can modify the coordinates and thereby change the position of an object. Place the cursor in the **Position** field and modify the coordinates in the window displayed. The first coordinate determines the location in the horizontal direction (**Object position x**), the second one determines the location in the vertical direction (**Object position y**). An object can also be repositioned in the edit area – see **Repositioning an Object** (p. 47).

- ◆ The **Size** of an object is displayed as a number of pixels (dots). The first size component is the width and the second – the height. You can re-size an object by editing the values. The resizing operation can also be performed in the edit area – see **Re-sizing an Object** (p. 48). The **Position** and **Size** parameters are particularly useful when you need to arrange or align two or more objects precisely.
- ◆ The **Scaling** parameter allows you to adjust the object frame size to the size of the object. If the **Scaling** parameter is set to **Fit frame to content**, the object frame is the same as the size of the object. If the **Scaling** parameter is set to **Fit content to frame**, the size of the object is equal to the size of the frame (not available to text objects where an EBS built-in font is used and to barcode-type objects). If **Without scaling** is chosen, the frame size can be modified without resizing the object.
- ◆ The **Object rotation** parameter allows you to rotate the entire object clockwise (the setting of 90), counterclockwise (the setting of 270) or "upside down" (the setting of 180).
- ◆ If the **Transparent** parameter check box is ticked, the object is transparent and you can see an object that is 'under' it. This property is useful when a number of objects have been placed in the edit area and there is a risk that objects overlap each other.



In the **Text** sheet tab (available for text objects):

- ◆ You can change the type of font by modifying the **Font name** parameter. EBS  built-in fonts and True Type ( or ) fonts are available. If a font is marked with  (with the  button after the font name has been highlighted), it is added to *favorites* and moved to the beginning of the font list.
- ◆ For the EBS  built-in fonts you can modify the **Row multiply** and **Letter spacing** parameters. The **Row multiply** parameter defines how many times printing of every vertical row of text is to be repeated. The multiplication of rows is used in order to increase intensity of prints on porous materials, which absorb ink heavily, and on which the characters (consisting of the same size dots) printed are not well visible due to their

grainy structure. The **Letter spacing** parameter defines the space between object characters. The space is given as a number of vertical rows (up to 1000 rows).

- For the True Type fonts (default fonts **T** and user fonts **U**) you can modify the **Font size** parameter (given as a number of pixels). The parameter is linked with the **Constrain font proportions** parameter. The **Font size** (the font width and height) can be modified proportionally (when the check box of the **Constrain font proportions** parameter is ticked) or either of the components, the width (**Font width**) and the height (**Font height**) can be modified independently (the check box of the **Constrain font proportions** parameter is unticked).
- With the **Line spacing** parameter you can add spaces between lines of text. The spaces are measured in pixels (dots). Up to 20 pixel spaces can be added. The space is added after every end-of-line character.

The screenshot shows the 'Text' settings screen with the following values:



- Font name: fonts/Default/Font_32x24.xml
- Line spacing: 1
- Letter spacing: 1
- Row multiply: 1
- Edit text before printing is started: [X]

At the bottom, there is a red button with a white 'X' and a green button with a white checkmark, both labeled 'Text 1'.



The screenshot shows the 'Text' settings screen with the following values:

- Font name: fonts/Default/FreeSans.ttf
- Line spacing: 0
- Font size: 30
- Constrain font proportions: [checked]
- Edit text before printing is started: [X]





At the bottom, there is a red button with a white 'X' and a green button with a white checkmark, both labeled 'Text 1'.

Touch the  button in order to confirm the modifications or the  button in order to abandon any changes. If no changes have been made, you can return to the previous screen by touching  button.

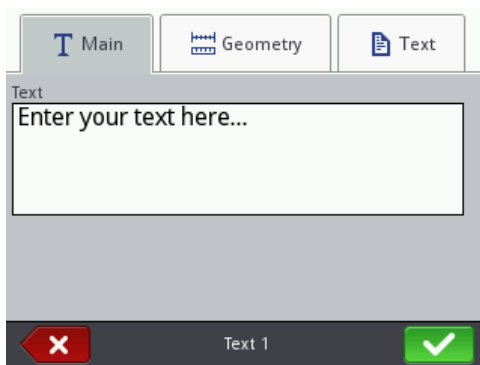
Text Object – Normal text



Touch the  button and then the  button in order to add a new text object - **Normal text**, to a project.





You can type in any string of characters in the **Text** field of the **Main** sheet tab. The division of a text into lines can be done by touching the ENTER button on the keypad displayed. On finishing the typing in, confirm the text with the  button. Touch the  button in order to add the object to a project or the  button in order to abandon the addition. If no changes have been made, you can return to the previous screen by touching  button.

Text Object – Date/Time

The **Date/Time** text object allows you to print the current date and the current time and also an expiration date automatically.

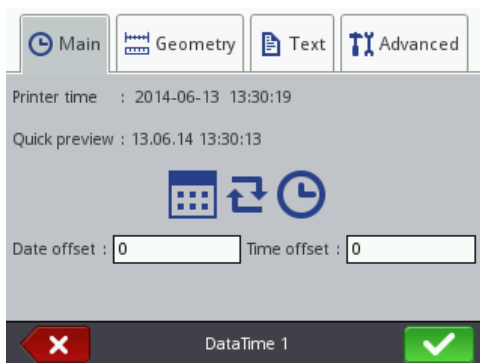
Touch the  button and then the  button in order to add a new, **Date/Time**-type text object to a project.



The current date and time generated by the printer clock are given in the **Main** sheet tab, where you can also preview a time and/or date print. With the 

clock icon or the  calendar icon you can choose components for printing – the date, the time or both of them. You can change the order of these

components with the  arrow icon.

The **Date offset** parameter allows you to shift the current date by a set number of days, in order to include an expiration date, for example.

The **Time offset** parameter allows you to readjust the current time by a set number of hours (up to 24). The modification can impact on date shifting. Such a change may cause a calendar day to start at a different time than 00:00 (e.g. at 6 o'clock a.m., when a morning shift in the factory starts).

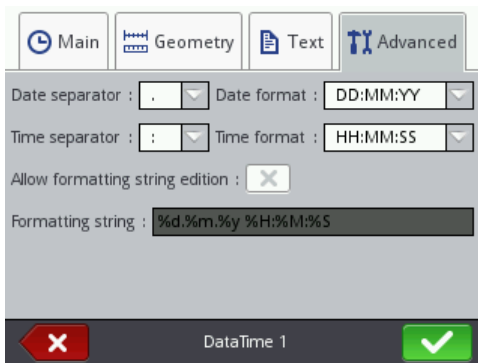

In the **Advanced** sheet tab you can modify the **Date separator** and **Time separator** parameters (for selecting separators to be used between date/time components) and also **Date format** and **Time format** (for selecting the sequence of the date/time components).

The default settings of date and time formats and separators for newly created **Date/Time**-type text objects can be modified in the Settings menu – see **General Settings** (p. 21).

The **Formatting string** parameter is available when the **Allow formatting string edition** check box is ticked. Below there are the characters with which the date and time components are coded. Any characters that are different from those mentioned below and also spaces can precede, separate or follow the successive components of the universal-date special registers. If no local name exists, an English equivalent is displayed.



%a – local short form for the name of day of the week (Mon, ... , Sun),

%A – local full name of day of the week (Monday, ..., Sunday),

%b – local short form of the name of month (Jan, ... , Dec),



%B – local full name of month (January, ... , December),

- %c – local date and time in the following format: short form for the name of day of the week, short form for the name of month, day of the month, hours, minutes, seconds, year,
- %C – number of century,
- %d – day of month (01, ... , 31)
- %D – date in the format: mm/dd/yy,
- %e – day of month (1, ..., 31),
- %F – date in the format: yyyy–mm–dd,
- %g – 2–digit year corresponding to the number of week %V,
- %G – 4–digit year corresponding to the number of week %V,
- %h – local short form for the name of month (Jan, ... , Dec),
- %H – hour, in 24–hour system (00–23),
- %I – hour, in 12–hour system (01–12),
- %j – day of year (001, ... , 366),
- %k – hour, in 24–hour system (0–23),
- %l – hour, in 12–hour system (1–12),
- %m – month (01, ... , 12),
- %M – minute (00, ... , 59),
- %p – local equivalent to AM or PM (empty on many sites),
- %P – local equivalent to a.m. or p.m. (empty on many sites),
- %r – time in 12–hour system in the format: hh:mm:ss [AM] or [PM],
- %R – time in 24–hour system in the format: hh:mm,
- %s – number of seconds from 00:00:00, 1 January 1970 (extension GNU),
- %S – second (00, ..., 60); 60 means a leap second,
- %T – time in 24–hour system in the format: hh:mm:ss,
- %u – day of the week (1, ... , 7); 1 means Monday,
- %U – number of the week in year (00, ... , 53), Sunday starts the week,
- %V – number of the week in year (01, ... , 53), Monday starts the week,
- %w – number of day of the week, 0–Sunday, 1–Monday, etc.,
- %W – number of the week in year (00, ... , 53), Monday starts the week,
- %x – local representation of the date,
- %X – local representation of the time,
- %y – two last digits of year (00, ... , 99),
- %Y – year in the format yyyy,
- %Z – time zone in numerical format compliant with RFC–2822 (e.g. +0100) (non-standard extension),
- %Z – time zone (e.g. EDT) or nothing, if no zone can be determined.

Touch the  button in order to add the object to a project or the  button to abandon the addition. If no changes have been made, you can return to the previous screen by touching the  button.



Text Object – Counter

The **Counter** text object allows you to print automatically a consecutive number on every successive article to be labeled. The setting of the counter changes each time the trigger is pressed.

Touch the  button and then the  button in order to add a new, **Counter**-type text object to a project.



In the **Main** sheet tab you can choose how many sections the **Counter** is to have. For simple counting of articles, it is enough to use one, the first section and the default settings to create a counter-type object. You can use a cascade of up to 3 identical sections. Each of the sections can be visible (displayed) or not.

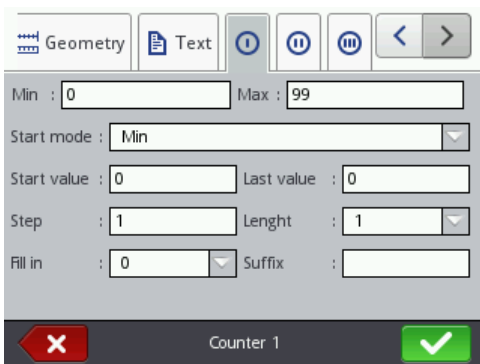

By touching  () you can change the **Increment order**. The parameter defines which of the sections is considered as first and what the timing order is. The section timed first receives a timing pulse whenever a print is to be made. Every successive section receives a timing pulse from the previous section, when that section has counted to the end (that is, to the **Max** setting when the counter is incremented or to the **Min** setting when it is decremented). The timing pulse modifies the counter by a set **Step**.



In every counter section you can configure each of the following parameters:



- ◆ **Min** – the setting from which counting starts (for counting up), or with which counting finishes (for counting down).

- ◆ **Max** – the setting at which a counter overflows. When a counter overflows, counting starts again from the **Min** setting.
- ◆ **Start mode** – the parameter allows you to set the value from which counting starts after printer operation has been resumed. Four options are available:
 - **Min**,
 - **Max**,
 - **Start value**,
 - **Last value**.
- ◆ **Start value** – the counter setting from which counting starts after operation has been interrupted, e.g. when the batteries discharge. This is effective when the **Start mode** parameter is set to **Start value**.
- ◆ **Last value** – the last setting of a counter, which is saved after the printer has been switched off in regular mode.
- ◆ **Step** – a counter increment. When the setting is a positive number, counting is incremental, and when it is a negative number, counting is decremental.
- ◆ The **Length** parameter is used to adjust the number of counter digit positions to that required by the user.
- ◆ The **Fill in** parameter is used to define a replacement for insignificant digits of a counter: 0 or space.
- ◆ **Suffix** – any character string to follow the counter printout, limited to 41 characters.

Touch the  button in order to add the object to a project or the  button to abandon the addition. If no changes have been made, you can return to the previous screen by touching the  button.

Text Object – Communications Port

The **Communications port** text object is used to print automatically the data that is transferred from external devices (e.g. a computer, automatic scales, a barcode reader) to the printer.

Touch the  button and then the  button in order to add a new, **Communications port**-type text object to a project.

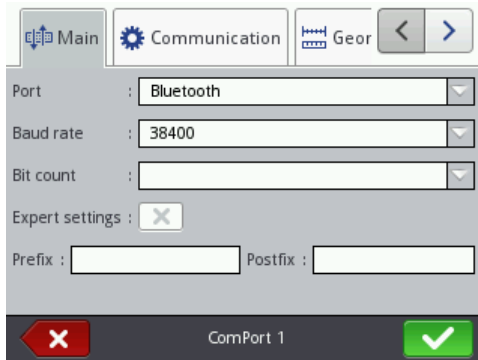

In the **Main** sheet tab you can set the parameters that are significant for establishing communication between the printer and an external device. The printer and the device must have the same settings of the following parameters to communicate successfully:

- ◆ **Port** – it defines the name of a printer port to which an external device is connected as a source of serial transmission signals in RS–232 standard, for example. There is no physical RS–232 interface in the printer, so you need to apply an USB – RS232 converter in order to connect an external device. With such a converter you can connect an external device (e.g. a computer, automatic scales, a barcode reader) to a USB port. External devices can be connected to the printer via a Bluetooth interface, which is a source of serial transmission signals and can be chosen for this object. The list of ports is fixed and contains Bluetooth and ports, from COM1 to COM9.
- ◆ **Baud rate** – it signifies a rate of transmission (a number of symbols per second) through the port. The list to choose from contains the most typical rates used for serial communication. If the **Port** parameter is set to Bluetooth, the **Baud rate** setting cannot be modified.
- ◆ The **Bit count** parameter defines the number of bits in every portion of the data transferred. If the **Port** parameter is set to Bluetooth, the **Bit count** setting cannot be modified.

In addition, you can enable **Expert settings** (see the **Advanced** (p. 59) sheet tab) in the **Main** sheet tab and create a text that will precede (**Prefix**) or follow (**Suffix**) the data to be received from an external device.

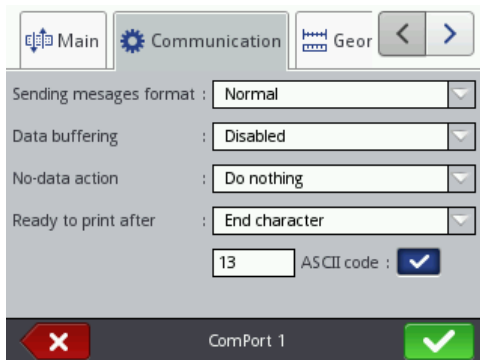

In the **Communication** sheet tab you can set communication parameters, which define the rules for communication between the printer and an external device:

- ◆ **Sending messages format** – this parameter defines the format of data to be transferred from the printer to a device. Two modes are available: **Normal** and **Hexadecimal**. In the normal mode, the data is transferred as ASCII characters, whereas in the hexadecimal mode it is transferred as hex numbers.
- ◆ **Data buffering** – it is used for storing successive data portions in a special register, **Communications port**. Two modes can be set:
 - **Enabled** – a successive portion of the data received by the special register is stored if the end condition is met – see **Ready to print after**. The buffer size is 20, which means that 20 various, ready-to-print pieces of data can be received and stored. When any other data comes, it will overwrite the data at the 20th position and a long sound is heard at the same time to inform about the overflow. The data buffer forms a kind of queue, the data is printed in the same sequence in which it has been received by the special register. If all the data buffered is printed out, and another print is released, the printer behaves according to the **No-data action** parameter setting.
 - **Disabled** – a successive portion of the data received by the special register overwrites the data that has been received earlier but has not been printed yet. The data is overwritten until it is printed. If no other data is received subsequently, the printer behaves according to the **No-data action** parameter setting. In this mode, the last data received is the first printed.
- ◆ **No-data action** – it defines printer behavior when no data has come from an external device (when the end condition is not met – see **Ready to print after**) and printing of a project containing a **Communications port** object has been released. The following modes of operation can be set:
 - **Do nothing** – if printing is released when data is not received properly or the end condition is not met (see **Ready to print after**), the project is not printed. The message informing about this fact is displayed.



- **Print blank object** – the project is printed as usual, with the entire **Communications port** object being empty.
- **Print last message** – the project is printed together with the **Communications port** object, with the object being filled with the last message received successfully from an external device. If such a printout is made as a first, the project is printed but the area where the data should be is empty.



◆ **Ready to print after** – it defines how the printer decides whether it has received complete data (the end condition) from an external device or not. The following modes can be set in this parameter:

- **Time interval [ms]** – the printer waits for data over a certain time. The time is counted from the moment when a last project is printed or, if the **On data process** field (in the expert settings – see the **Advanced** (p. 59) sheet tab) is filled in – from the moment when an end-of-printing acknowledgement is sent. The time is typed in in the field below the parameter as a number of milliseconds (between 4 and 1000 ms). If no data is received within the defined time, the printer behaves according to the **No-data action** parameter setting.
- **Data count** – the printer is ready for printing a project containing a **Communications port** object when it receives a number (from 1 to 255) of characters from an external device; with the number being defined in the field below the parameter. If printing is released although the condition is not met (the defined number of characters has not been received) the printer behaves according to the **No-data action** parameter setting.
- **End character** – the printer is ready for printing a project containing a **Communications port** object when it receives data ending with a defined character from an external device, with the character being defined in the field below the parameter. In this mode you can also define an ASCII character that is to be the end of a portion of the data received. For that purpose, tick the **ASCII code** check box and type in the decimal value of the ASCII code. If printing is released when the condition is not met (the defined end-of-data character is not received) the printer behaves according to the **No-data action** parameter setting.

The screenshot shows a software interface for printer settings. At the top, there are three tabs: 'Advanced' (selected with a gear icon), 'Geometry' (with a grid icon), and 'Text' (with a document icon). To the right of these tabs are left and right arrow buttons. Below the tabs, there are four input fields with labels: 'On print start', 'On data process', 'On print finish', and 'Formatting string'. The 'On data process' field is currently selected and highlighted. The 'Formatting string' field contains the text '%s'. At the bottom of the interface, there is a dark grey bar with a red 'X' button on the left, the text 'ComPort 1' in the center, and a green checkmark button on the right.

In the **Advanced** sheet tab you can modify the **Expert settings**, which define the rules for processing of the data received from an external device, and also the mode of acknowledgement of printer states (starting printing, stopping printing, project printed) to the device:

- ◆ **On print start** – it defines the data to be transferred from the printer to the external device immediately after printing has been initiated (the  button (**W**) has been touched).
- ◆ **On data process** – it defines the data to be transferred from the printer to the external device each time a project containing the **Communications port** object has been printed.
- ◆ **On print finish** – it defines the data to be transferred from the printer to the external device immediately after printing has been stopped (with the  button (**W**)).
- ◆ **Formatting string** – this is an advanced mode of formatting of the data transferred from an external device to the printer. It describes how the incoming data is interpreted by Printing Manager. Marks applied: %s – a character string, %d – a number.

Touch the  button in order to add the object to a project or the  button to abandon the addition. If no changes have been made, you can return to the previous screen by touching the  button.

Text Object – Text File

The **Text file** text object is used to print the data saved in a TXT file.

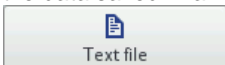

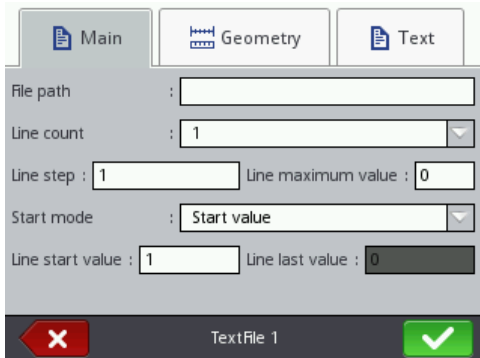
Touch the  button and then the  button in order to add a new, **Text file**-type text object to a project.





Touch the **File path** text field in order to roll-in a text file. On the screen displayed, choose the file name out of those listed (or type in the file name in the text field), and then touch the  button.

In the **Main** sheet tab you can set the following parameters:

- ◆ **Line count** – the number of lines to be added to the object from a text file.
- ◆ **Line step** – the number of lines by which text file data moves each time a print is made. If the **Line count** is greater than the **Line step**, the data moves by the number of lines given in the **Line count**.
- ◆ **Line maximum value** – the last line of a text to be included in a printout.
- ◆ The **Start mode** parameter is used to define which line of a text file is to be rolled-in after printer operation has been resumed. Two options are possible:
 - **Start value** – the line defined by the setting of the **Line start value** parameter is to be rolled-in,
 - **Last value** – the line shifted by the **Line step** in relation to the line on which printing finished is to be rolled-in.
- ◆ **Line start value** – the text line to be added to an object as a first one.
- ◆ **Line last value** – it indicates the line that has been printed as the last. The line is memorized provided that the printer is switched off properly – see **Switching the Printer Off** (p. 16).



Touch the  button in order to add the object to a project or the  button to abandon the addition. If no changes have been made, you can return to the previous screen by touching the  button.

Shape-type Object – Line

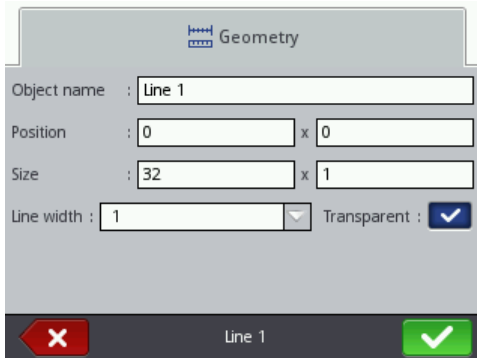

Touch the  button, choose the **Shapes** sheet tab, and then touch the  button in order to add a new, shape-type object, a **Line**, to a project.



The **Line width** can range from 1 to 30. The **Line width** is given as a number of dots.

Touch the  button in order to add the object to a project or the  button to abandon the addition. If no changes have been made, you can return to the previous screen by touching the  button.

Shape-type Object – Rectangle

Touch the  button and choose the **Shapes** sheet tab, and then touch the  button in order to add a new, shape-type object, a **Rectangle**, to a project.

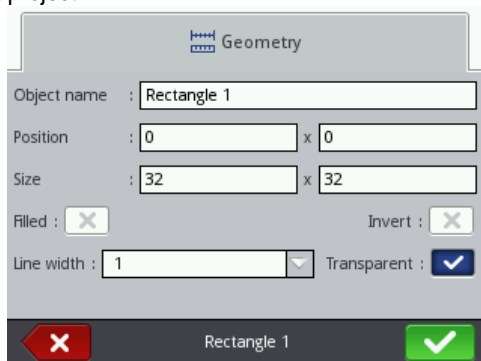



The screenshot shows a dialog box titled "Geometry" for creating a "Rectangle 1". It contains the following fields and controls:

- Object name : Rectangle 1
- Position : 0 x 0
- Size : 32 x 32
- Filled :
- Invert :
- Line width : 1
- Transparent :

At the bottom of the dialog, there is a red "X" button on the left, the text "Rectangle 1" in the center, and a green checkmark button on the right.

The **Rectangle** object allows you to print any rectangle: an outline only or the entire figure (in the latter case the **Filled** check box needs to be ticked). If the **Invert** check box is ticked, then where the **Rectangle** "covers" another object that is in a lower layer, the common part of the rectangle and that another object is not printed.

The **Line width** parameter can be used to set the outline thickness.

Touch the  button in order to add the object to a project or the  button to abandon the addition. If no changes have been made, you can return to the previous screen by touching the  button.

Shape-type Object – Ellipse

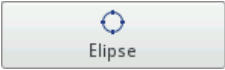

Touch the  button, choose the **Shapes** sheet tab, and then touch the  button in order to add a new, shape-type object, an **Ellipse**, to a project.

The screenshot shows the 'Geometry' dialog box for an 'Ellipse 1' object. The fields are: Object name: Ellipse 1; Position: 0 x 0; Size: 32 x 32; Filled: ; Invert: ; Line width: 1; Transparent: . At the bottom, there are three buttons: a red 'X' button, a green checkmark button, and a blue double-left arrow button.



The **Ellipse** object allows you to print any ellipse: an outline only or the entire figure (in the latter case the **Filled** check box needs to be ticked).

If the **Invert** check box is ticked, then where the **Ellipse** "covers" another object that is in a lower layer, the common section of the ellipse and that another object is not printed.

The **Line width** parameter can be used to set the outline thickness.

Touch the  button in order to add the object to a project or the  button to abandon the addition. If no changes have been made, you can return to the previous screen by touching the  button.

Barcode

Touch the  button, choose the **Other** sheet tab, and then touch the  button in order to add a new, **Barcode**-type object to a project.

The screenshot shows the 'Barcode' dialog box. It has three tabs: 'Main', 'Advanced', and 'Geometry'. The 'Main' tab is selected. Fields include: Barcode type: Internal EAN-13; Text: (empty); Barcode short description: Char Set: numeric 0-9, Length: corresponding to selected EAN barcode type. A barcode image is shown on the right. At the bottom, there are three buttons: a red 'X' button, a green checkmark button, and a blue double-left arrow button.

In the **Main** sheet tab, choose **Barcode type** and in the **Text** field, type in a character string that is to be presented as a barcode. Make sure that the code type fits the number and type of characters. When the **Text** field changes its

color to red, this means that the character string typed in is not appropriate to a given type of code (a wrong number or type of characters). The detailed information on code formats is displayed while a type of code is being chosen in the **Barcode short description** field.

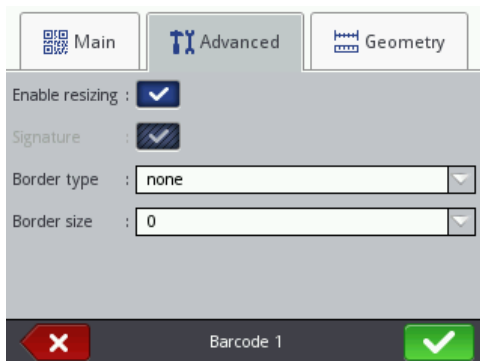

The following types of barcodes are available:

- ◆ Numerical: EAN-2, EAN-5, EAN-8, EAN-13, EAN-5 + EAN-2, EAN-8 + EAN-2, EAN-8 + EAN-5, EAN-13 + EAN-2, EAN-13 + EAN-5, Code 25, Code 11, Code 25 Industrial, Code 25 Interleaved, Code25 IATA, Code 25 Data Logic, Codabar, Leticode, Identcode, GS1 DataBar-14, GS1 DataBar Limited, GS1 DataBar Expanded, UPC-A, UPC-E, PostNet, MSI Plessey, Pharmacde One-Track, Pharmacde Two-Track, ITF-14, PZN.
- ◆ Alphanumeric: Code 39, Code 39 Extended, GS1-128 (UCC/EAN-128), Code 128, Code 16k, Code 93, Telepen Alpha, 2D:PDF417, 2D:PDF417 Truncated, 2D:QR Code, Australia Post 4-State, Royal Mail 4-State (RM4SCC), 2D:Data Matrix, 2D:MicroPDF417.





In the **Advanced** sheet tab you can modify the following parameters:

- ◆ If the **Enable resizing** check box is ticked, the code can be resized. If you change the code size and then untick the check box, the barcode regains its original size.
- ◆ **Signature** – the digital description of a code is to be printed beneath the code (it is available for selected codes).
- ◆ **Border type** – the type of barcode frame (it is available for selected codes); three types are available:
 - **none** – no frame,
 - **bind** – frame lines at the top and bottom of a code,
 - **box** – a code is framed on each side.If the **bind** or **box** option is chosen, set the **Border size** to a different setting than **0** to make the frame visible.
- ◆ **Border size** – the width of a barcode frame; it allows you to modify the frame width when the **Border type** is set to **bind** or **box**.



Touch the  button in order to add the object to a project or the  button to abandon the addition. If no changes have been made, you can return to the previous screen by touching the  button.

Image

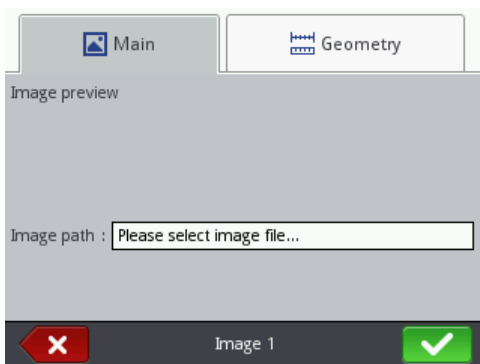
Touch the  button, choose the **Other** sheet tab, and then touch the  button in order to add a new, **Image**-type object to a project.





In the **Main** sheet tab touch the **Image path** check box. On the screen displayed, choose a file name out of those listed (or type in the file name in the white field), and then touch  button. The printer uses PNG files.

Touch the  button in order to add the object to a project or the  button to abandon the addition. If no changes have been made, you can return to the previous screen by touching the  button.

Line Divider

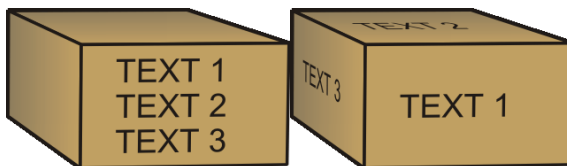

If a division mark is added to a project, you can make printouts of several text files quickly on successive lines or on various spots on an article.



Touch the  button, choose the **Other** sheet tab, and then touch the  button in order to add a new, **Line divider**-type text object to a project. With the **Position** parameter you can define the number of the vertical row on which the division should be made.



You can start modifying and printing divided projects by pressing trigger **6**.

Touch the  button in order to add the object to a project or the  button to abandon the addition. If no changes have been made, you can return to the previous screen by touching the  button.

Printing Parameters

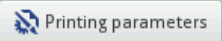
The printing parameter window is displayed after the  and  buttons have been touched in turn – see **Project Processor** (p. 42).

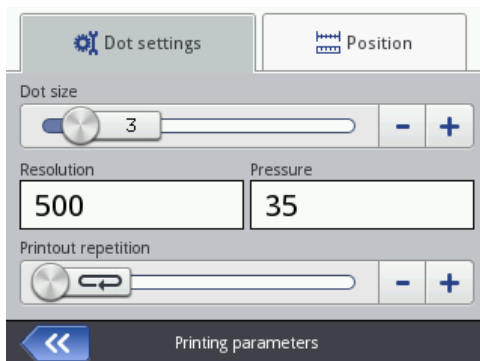

In the **Dot settings** sheet tab:

- ◆ The **Dot size** parameter is used in order to increase the intensity of prints on porous materials, which absorb ink heavily, on which the characters printed (consisting of the same size dots) are not well visible due to their grainy structure. An increase in the setting of that parameter results in higher intensity of prints made, owing to a bigger size of ink drops jetted out of the printer head. Increased intensity involves higher consumption of ink. Intensity is physically constrained by the real speed at which the head can print – it means that when the intensity is too high for a given printing speed, the printer signals an error with an audible signal (provided that an appropriate warning is set – see **Sound Settings** (p. 23)), and higher intensity also limits the printing speed.
The parameter is also available on the main screen– see **Operating Touch Screen** (p. 12), item **R**.
- ◆ The **Resolution** parameter impacts on the visibility of the project characters after they have been printed. It decides on print resolution, which is given as a number of rows/meter. In other words, a change in the width of characters printed and in the length of the entire project are the visual effects of a change in the setting of the **Resolution** parameter.
This parameter is available also on the main screen – see **Operating Touch Screen** (p. 12), item **S**.
The printer is equipped with a practical tool, **Measure**, which is designed for adjustment of print resolution to the length of the surface to be labeled – see page **119**.
- ◆ With the **Pressure** parameter you can adjust the force by which ink drops are jetted, to the type of surface to be labeled. Lower pressure is recommended for smooth, non-absorbing materials, and higher – for porous, absorbing materials. Pressure settings can vary from 15 to 45 bars. If too low pressure is set, ink may solidify on nozzles. If too high pressure is set, irregular ink splashes (so called satellites) may occur around a print.
Detach the ink container from the printer in order to reduce the pressure of the ink in the container, if you need to print a project where lower pressure is set than that in the project printed before.
- ◆ The **Printout repetition** parameter defines how many times a print is to be re-printed after the trigger has been pressed. It allows you to make a print repeatedly on the same article (repetition). Continuous repetition of prints can be set for continuous articles (e.g. cables, hose, tubes, pipes) (**Printout repetition** = ). The distance between successive prints is set with the **Print spacing** parameter – see the **Position** (p. 67) sheet tab.

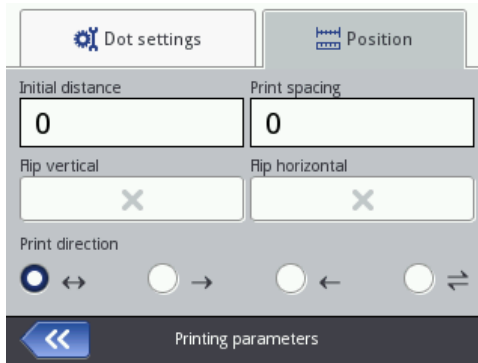

In the **Position** sheet tab:

- The **Initial distance** parameter defines the distance from the point where the print release button is pressed to the point where printing of a print should start. The distance is given as a number of millimeters, and it is measured after the trigger has been pressed and before printing starts. It enables you to adjust the print position in relation to the beginning of the article.
- The **Print spacing** parameter defines the distance between the beginnings of prints that are made repeatedly (**Printout repetition >1**). The distance is given as a number of millimeters.
NOTE: If the distance set with the **Print spacing** parameter is smaller than the print length, prints are printed one just after another.
- The **Flip vertical** parameter defines the mode of printing in the vertical direction: normal or turned upside down. It can be useful when an article to be labeled is turned.



- The **Flip horizontal** parameter can be useful if you need to label articles from right to left or if you print on transparent materials and the prints should be legible from the opposite side.





- Reversed print 



- The **Print direction** parameter defines in which direction the printer should be moved in order to make a print.

- ↔ – a print is made when the printer is moved left and right.
- → – a print is made only when the printer moves right. The system detects any movement of the printer in the opposite direction automatically and interrupts printing. When the printer starts moving right again, it resumes the printing from the point at which it moved in the opposite direction. In order to ensure that a printout hits precisely the point at which the printer moved in the opposite direction and the printing was interrupted, lower roll **3** of the printer must have continuous contact with the surface to be labeled.
- ← – a print is made only when the printer moves left. The system detects any movement of the printer in the opposite direction automatically and interrupts printing. When the printer starts moving left again, it resumes the printing from the point at which it moved in the opposite direction. In order to ensure that a printout hits precisely the point at which the printer moved back and the printing was interrupted, lower roll **3** of the printer must have continuous contact with the surface to be labeled.
- ⇌ – a print is made when the printer moves left or right. The direction of printing is chosen with a first movement of a roll. Printing can continue only in the direction originally chosen. The system detects any movement of the printer in the opposite direction automatically and interrupts printing. When the printer moves in the original direction again, it resumes printing from the point at which it moved in the opposite direction. In order to ensure that the printout hits precisely the point at which the printer moved in the opposite direction and the printing was interrupted, lower roll **3** of the printer must have continuous contact with the surface to be labeled.

Touch the  button in order to approve the changes to the parameters, or the  button to abandon the changes. If no changes have been made, you can return to the previous screen by touching the  button.

Project Recovery

If the printer is switched off, e.g. in emergency mode, while a project is being edited but has not been saved yet, then when the printer is switched on again and the project is opened for editing, a project recovery tool starts running.

In the screen displayed, touch the check box of a project that you wish to edit. If you choose the original project and approve your choice with the  button, the recovered project is deleted (the deletion needs confirming on the screen displayed). If you choose the recovered project, then it is saved in printer memory under a name you may choose.



Service

With the service options available in the Service menu you can do the following:

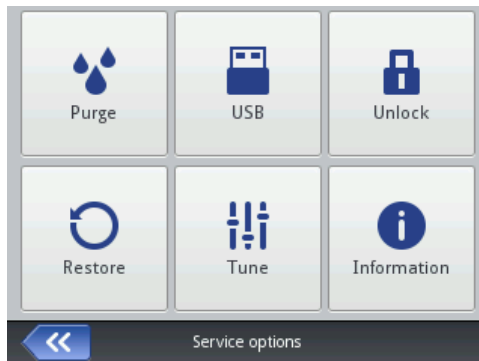

- ◆ make your printer ready for operation – by purging the head in order to vent it, e.g. after transportation, or to clear choked nozzles,
- ◆ update printer software, export or import projects,
- ◆ enable additional options,
- ◆ restore preliminary settings and data stored in printer memory,
- ◆ adjust electromagnets in nozzle valves,
- ◆ view the manufacturer's contact details and the version of printer software.



Purging

NOTE: Before starting purging direct the outlet of the nozzles **2** to a vessel, e.g. the one that is used for washing the printer!!!

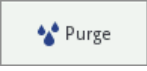
The purging function is used for clearing slightly choked nozzles or for removing air from the head. Make several sample prints after purging. If the print quality turns out to be unsatisfactory, start purging again. The purging is initiated by pressing trigger **6** and holding it in that position. When you do that, all head electromagnets open and ink starts flowing out at pressure! When you relax the trigger, the purging stops. Purging can be initiated in several ways:

- ◆ by touching the **Tools (U)**, **Service** and **Purge** buttons in turn,
- ◆ by touching the  button (**W**) and holding it until a drop-down menu appears; then choosing ,
- ◆ by pressing trigger **6** quickly three times and holding it for a few seconds. NOTE! As the result, an audible warning signal is generated by buzzer **34** , then all head electromagnets open and ink starts flowing out at pressure!

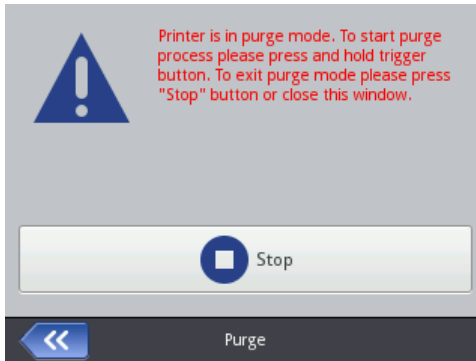

When air accumulates in the ink container (e.g. when the container is removed and installed again), the ink system should be vented by purging. In order to purge the system you should position the printer with the container downwards and start purging. Hold trigger **6** until ink starts flowing out of the nozzles.



USB

See [Connecting USB Disc to the Printer](#) (p. 34).

Unlocking Options

You can use additional options to extend printer functionality or enable the functions that have been constrained in order to protect the printer against accidental damage (e.g. which may occur when a wrong type of ink is used). Touch the **Tools (U)**, **Service** and **Unlock** buttons in turn.

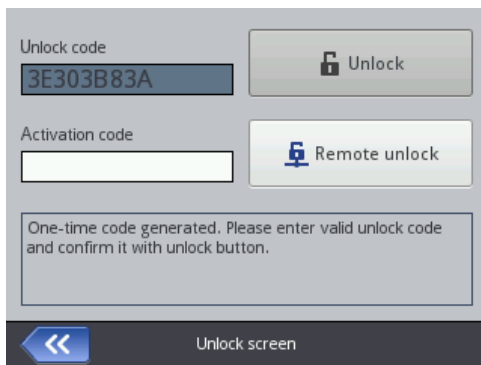

EN

The options can be unlocked in two ways:

- ◆ standard mode – after you have given the **Unlock code**, a serviceperson gives you an activation code in return. The activation code should be typed in in the **Activation code** field via the keypad displayed and confirmed with



button. Then the



button should be touched.

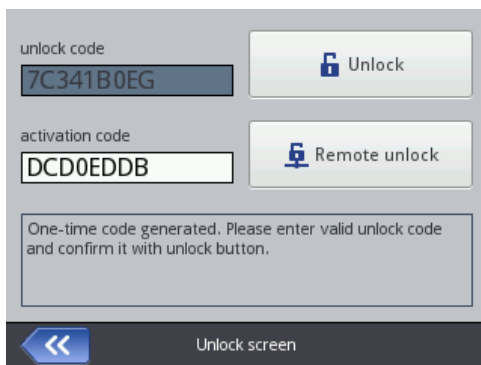

- ◆ remote mode – a serviceperson unlocks the printer remotely, without any need for giving a one-off code and typing in an activation code. Touch the

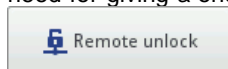

button and wait until the option is unlocked. The

unlocking procedure may take up to 5 minutes. Remote unlocking of options requires that the printer be connected to the Internet.

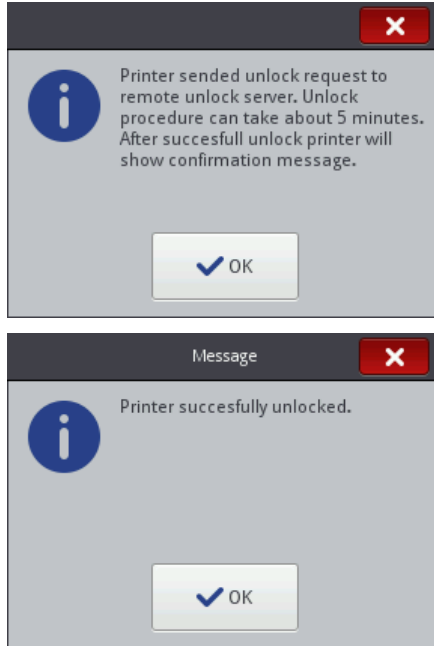

Before starting the standard or remote unlocking procedure you should contact an authorized serviceperson by phone.

Restoring Preliminary Settings

Touch the **Tools (U)**, **Service** and **Restore** in turn.

Preliminary settings of the printer can be restored after the password has been typed in on the screen displayed. When the Restore function is used, the user projects, fonts and images as well as energy, sound, language and date and time format settings are erased. The restoration of the preliminary settings is irreversible and for that reason it is recommended that data is exported beforehand – see **Export Project** (p. 79).

The **Restore** function is available only for Administrators. Preliminary settings should be restored only when the batteries are fully charged or when mains electricity supply is connected.

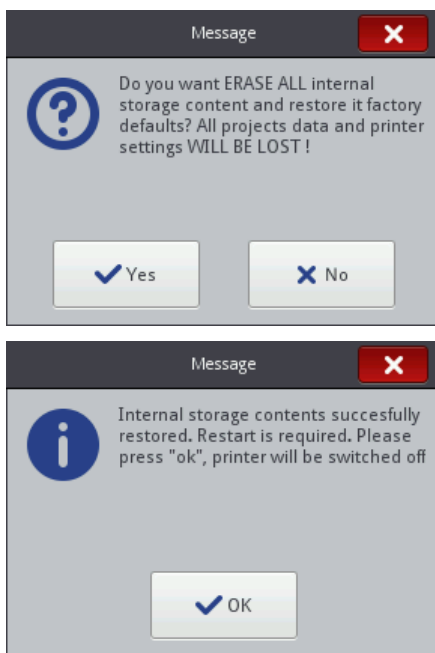

Tuning

The tuning function is used for adjusting badly printing nozzles of the printer. The function can be performed by the staff who have been trained in servicing EBS printers.

Information

Touch the **Tools (U)**, **Service** and **Information** buttons in turn.

On the **Product information** screen you can view the manufacturer's contact details and the version of printer software.

For the user who operates the printer on a standard basis, it is important to have the information on the **System version**. Owing to it you can check whether you have up-to-date software version installed on the printer.

The other data, such as the version number or the serial number of the printer (available after the **Detailed information** box has been touched) is necessary for service persons to perform diagnostic operations.

Operating the Printer via Mozilla Firefox Web Browser

The printer can be operated via a Web Browser in two ways:

- by establishing connection with the printer via WIFI and running *EBS Web User Interface (WUI)* – see **Establishing Connection between Printer and Computer** (p. 74).
- by using *Offline EBS Web User Interface (Offline WUI)* after it has been installed on the computer in advance.

The **Service** (p. 114) and **Printer Control** (p. 116) menus are not available in *Offline WUI*.

Establishing Connection between Printer and Computer

Follow the below given steps to connect the printer with a computer:

1. Configure a WiFi wireless network,
2. Set the WiFi network parameters on the printer – see **Connecting the Printer to a New Network via WiFi** (p. 30).
3. Read the IP Address of the printer on the **Wireless network status** screen – see **WiFi Wireless Connection** (p. 29), and type it in into the Web Browser (Mozilla Firefox).

EBS Web User Interface (WUI) displays on the computer screen.

Installing Offline EBS Web User Interface

The *Offline EBS Web User Interface* installation file is available on the printer web site at <http://www.ebs-inkjet.pl/ebs260> in the Information Materials sheet tab. Follow the installation manual attached to the installation file.

Logging In

You are logged in automatically as Administrator by default (default password: 1). You can disable automatic logging in or change the default account - see **Users Manager** (p. 109).

When the automatic logging in is disabled and *EBS Web User Interface (WUI)* starts running, a list of users is displayed on the startup screen. Point at the name of a user with the cursor and type in the password in the text field. After you have logged in, you will see that printer interface functions vary according to the user group you are assigned to – see **Users Manager** (p. 109).

Work Screen of EBS Web User Interface

The work screen consists of the following:

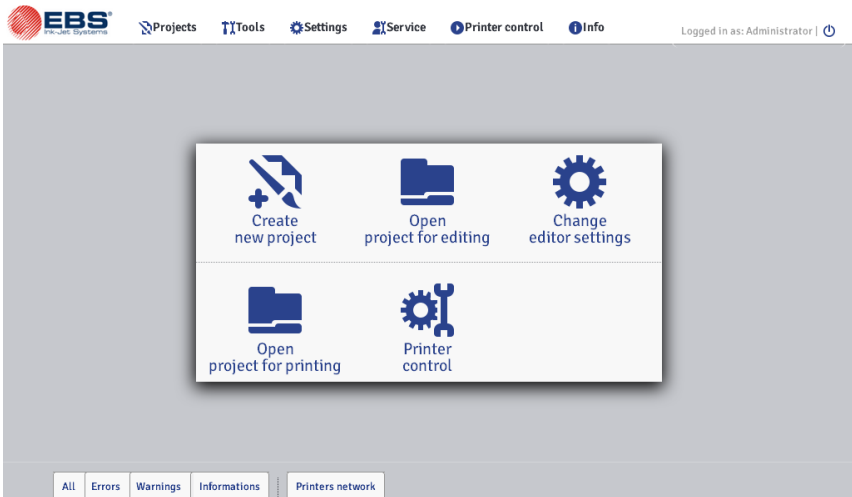

- WUI MENU (**Projects** (p. 76), **Tools** (p. 106), **Settings** (p. 113), **Service** (p. 114), **Printer Control** (p. 116), **Info** (p. 117) and user status as well as the OFF/restart/log out button),
- WUI module (**Create a New Project** (p. 76), **Open and Edit a Project**, (p. 76) **Change editor settings** (p. 113)),

- ◆ Printer control module (**Open project for printing** (p. 119), **Printer Control** (p. 116)).
- ◆ Message bar – see **Messages** (p. 117), and a printer network.





EN



Description of the window title bar buttons:

- ◆  – background view,
- ◆  – help,
- ◆  – close the window (hot key: **[ESC]**).

File Manager

You can manage file and folder names in the following windows: **Create new project**, **Open project** (**Open project for editing**) or **Save as....**

Touch the  button in order to create a new folder. Type in the name of the new folder in the window displayed and confirm with the  button.

Highlight the name of a file or folder in the list, and then touch the  button to delete the file or folder. Highlight the name of a file or folder in the list and touch the  button in order to change the name. Type in a new name in the window displayed and confirm with the  button.

Projects

Create a New Project

In the **Projects** menu, which is on the menu bar, you can choose the **Create new project** command. Type in a name for your project in the **Filename** field in the window displayed. If you tick the **Create project in separate directory** check box, a folder is created with the same name as the name of the project. In the drop-down list choose the type of the printer for which the project is designed (only when *Offline WUI* is used), and

then touch the **Create project** button.

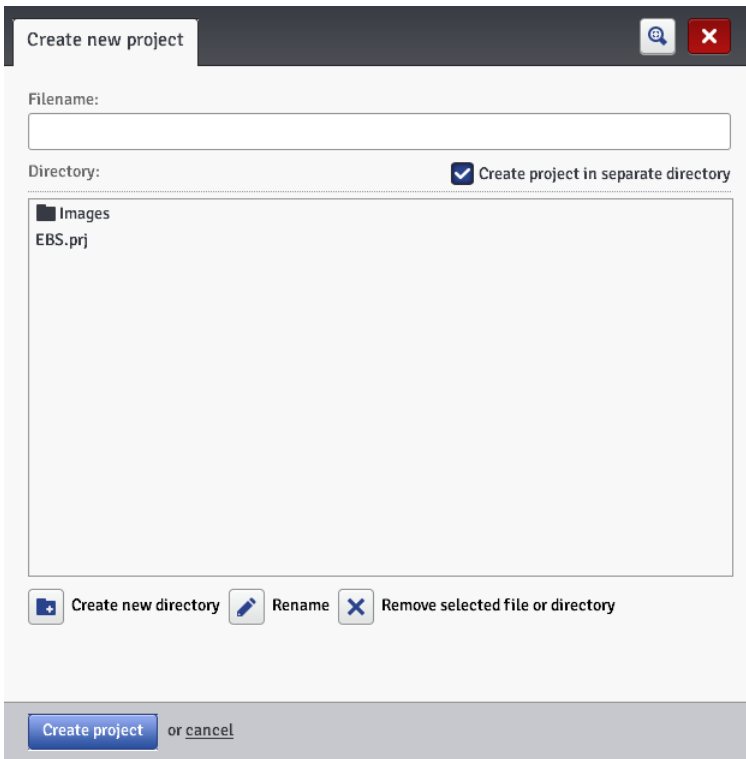

Open and Edit a Project

In the **Projects** menu, which is on the menu bar, choose the **Open project** command. Highlight the name of a project in the list you can see in the window

displayed, and then touch the **Open project** button. When the name is highlighted, a **Project preview** section is displayed next to the project list whereas beneath the window you find the information about the project: when

Last modification was made and with the **Printer type** option - the type of printer for which the project is designed.

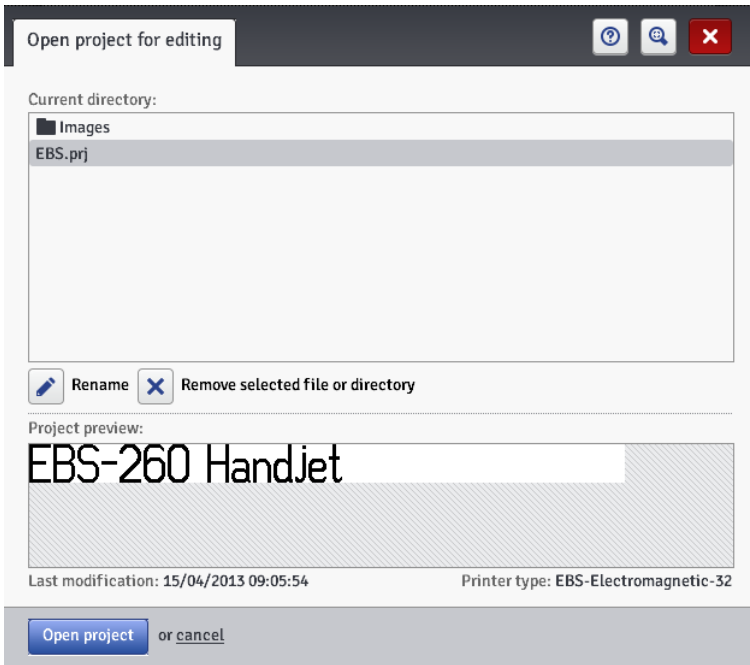

EN

If you open a project while a project is already open on the printer, the following message is displayed:

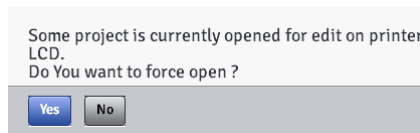

The project open on the printer must be saved before any project can be opened in *WUI*. Otherwise, the project is closed but not saved and any modifications made to it are lost.

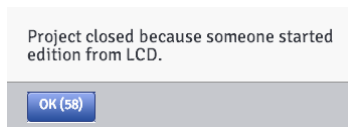

If you open a project on the printer LCD while the same project is being edited by means of *WUI*, the *WUI* project is closed automatically. No project can be edited on the printer screen and in *WUI* at the same time.



If you wish to continue editing the project that is open on the printer, touch the **Continue edition** button on the *WUI* working screen.





Import a Project

In the **Projects** menu, which is on the menu bar, choose the **Import project** command. You can import projects that are saved on another computer or have been created and edited on the printer itself. In the **Import EBS WWW Editor project** sheet tab, choose a file to be imported (by touching the text field or the  button) and touch the  button.

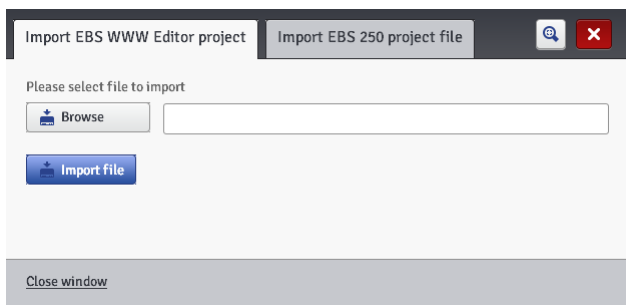
You can also import projects created for the HANDJET EBS-250 printer.



In the **Import EBS 250 project file** sheet tab, type in a name for the project in the **Filename** field, and then choose the file to be imported (by touching the text field or the  button) and touch the  button. When you have imported the entire project library, the name typed in in the **Filename** field becomes the folder name and the library projects are numbered with successive numbers.

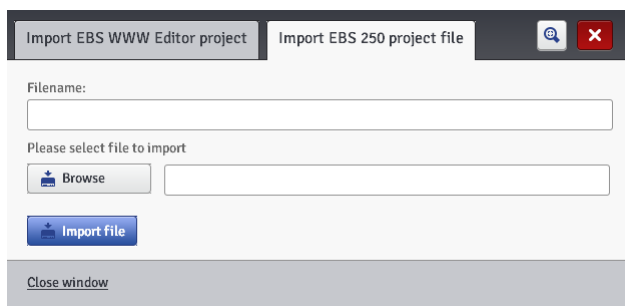

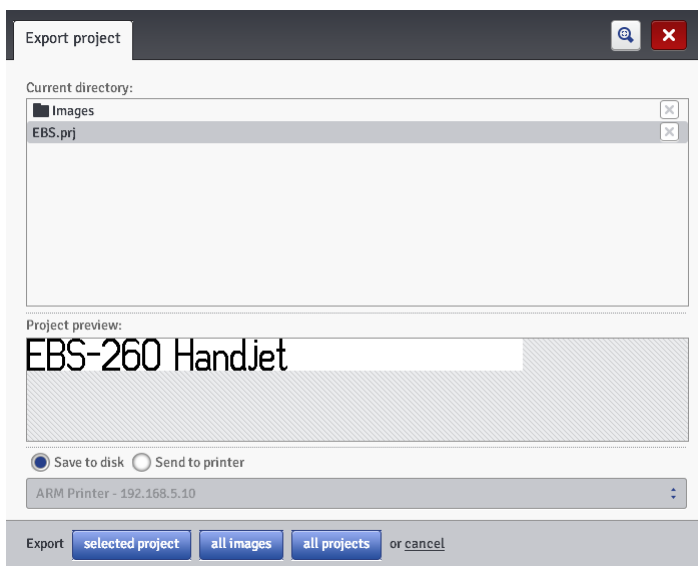

Export Project

In the **Projects** menu, which is on the menu bar, choose the **Export project** command. Projects and also images that are on printer disc can be exported for use on another printer or as a backup copy.



You can copy the following:

- ◆ All images saved in the *Images* folder – with the  button.
- ◆ One, selected project (highlighted in the list) – with the  button.
- ◆ All projects saved in internal memory of the printer – with the  button.

They are exported to:

- A disc file – files are exported as .exp files (choose the **Save to disk** circle),
- A printer to be chosen in the drop-down list (choose the **Send to printer** circle). If the printer you would like to export to is not in the drop-down list, you can add such a printer to the list (see **Printers Network Manager** (p. 110)).

Project Processor





Open a project with the **Create new project** or **Open project** command – the project processor window opens.

The project processor consists of several parts: an edit area, four tool bars and auxiliary rulers.



















The edit area height is adjusted to the type of print head to be used and fits a maximum print height. The edit area width can be modified. Touch and hold the re-sizing marker, which is on the right-hand tool bar, and move it right or left. The edit area width can also be modified with the **Workspace width** (p. 112) function that is available in the **Tools** menu.

Tool bars:

first horizontal bar		save project
		open and edit project
		project name
		printing parameters for project – see Printing Parameters (p. 83)
		edit area width – see Workspace width (p. 112)

		print preview (hot keys: CTRL + P), successive print: , return to first printout: , re-scaling of print preview (real size /fit to window width):		
		zoom in edit area (hot key: +)		
		zoom out edit area (hot key: -)		
		restore original size of edit area (hot key:)		
		magnification scale		
second horizontal bar		list of objects		
			up (hot key: ↑)	
		set object position (move a selected object within edit area by 1px)	down (hot key: ↓)	
			left (hot key: ←)	
			right (hot key: →)	
			object parameters	
		delete object (hot key: DEL)		
		justify object within edit area	left justify	
			center	
			right justify	
	cut objects (hot key: CTRL + X)			
	copy objects (hot key: CTRL + C)			
left vertical bar		normal cursor		
		add text object		type: Normal text – see <i>Text Object – Normal Text</i> (p. 88)
				type: Date/Time – see <i>Text Object – Date/Time</i> (p. 89)
				type: Counter – see <i>Text Object – Counter</i> (p. 91)
				type: Communications port – see <i>Text Object – Communications port</i> (p. 93)

		type Text file – see Text Object – Text File (p. 98)
		add Image -type object – see Image (p. 99)
	add barcode-type object – see Barcode (p. 100)	 Normal barcode
		 Date/Time as barcode
		 Counter as barcode
		 Data transferred via Communications Port as barcode
		 Text file data as barcode
		
 Rectangle – see Shape-type Object – Rectangle (p. 103)		
 Ellipse – see Shape-type Object – Ellipse (p. 104)		
	add special object	 Line divider – see Line Divider (p. 104)
right vertical bar		list of project objects – see List of Objects (p. 105)
		clipboard (hot key: CTRL + V) – see Clipboard (p. 106)
		deleted objects (hot key: CTRL + T) – see Trash (p. 106)

With the auxiliary rulers you can estimate the real size of a printout. The ruler is scaled in centimeters.

Choose **Save** (hot key: **CTRL**+**S**) in the **Projects** menu in order to save

a project. You can also save modifications with the  button that is on the first horizontal tool bar.

Choose **Save as...** (hot key: **CTRL**+**SHIFT**+**S**) in the **Projects** menu in order to save a project with any name.

Choose **Close project** in the **Projects** menu in order to close a project.

Printing Parameters

The printing parameters window is displayed by touching the  button (see **Project Processor** (p. 80)) or choosing **Printing parameters** in the **Projects** menu (the parameters are available in the menu list, when a project is open and can be edited).

The printing parameters are set to their default settings that are specific to a given type of printer.

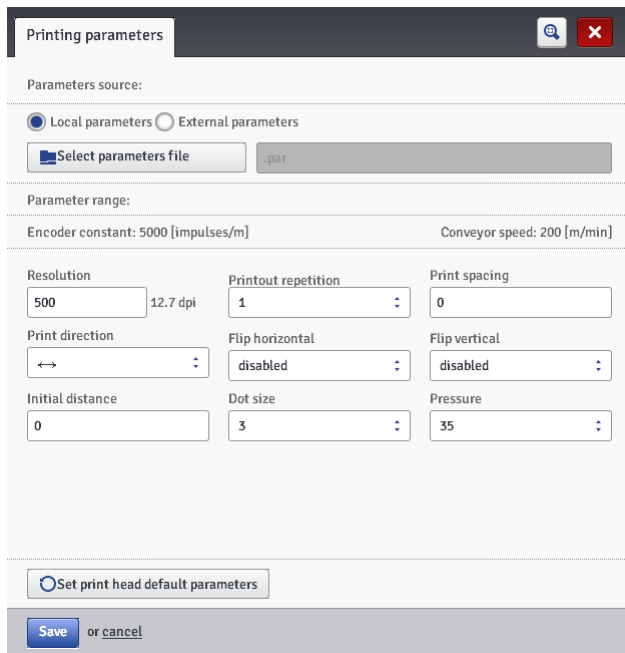

Printing parameters

Parameters source:

Local parameters External parameters

-par

Parameter range:

Encoder constant: 5000 [impulses/m] Conveyor speed: 200 [m/min]



Resolution	Printout repetition	Print spacing
500 12.7 dpi	1	0
Print direction	Flip horizontal	Flip vertical
↔	disabled	disabled
Initial distance	Dot size	Pressure
0	3	35

or

The printing parameters can be set in a table (**Parameters source: Local parameters**) and they are different for every project.

You can also import the parameters from a file that must be compiled in advance (**Parameters source: External parameters**). This option is very useful when a set of parameters is common for a number of projects. Any modification to the parameter file will apply at the same time to all the projects where a given parameter file is used.

Touch the button in order to read-in parameters from an external file; highlight a parameter file in the list in the "Review parameter files" window, and then touch the button.

In the "Review parameter files" window you can save the parameter settings to a file by touching the  **Create new file** button. Type in a name of the file and confirm with the  button in the window that follows.

The ranges of the parameters are given in the upper part of the window (above the division line) after the field of a parameter has been highlighted.

- ◆ The **Resolution** parameter impacts on the visibility of the project characters after they have been printed. It decides on print resolution, which is given as a number of rows/meter. In other words, a change in the width of characters printed and in the length of the entire project are the visual effects of a change in the setting of the **Resolution** parameter.

NOTE: The setting of the **Resolution** parameter is limited not only by the setting range. The real setting is controlled by the printer control program and can be constrained by the settings of other printing parameters. An automatic protection against too high a printing speed setting is applied. Therefore it may happen that certain settings are not accepted once other parameters are set.

- ◆ The **Printout repetition** parameter defines how many times a print is to be re-printed after the trigger has been pressed. It allows you to make a print repeatedly on the same article (repetition). Continuous repetition of prints can be set for continuous articles (e.g. cables, hose, tubes, pipes) (**Printout repetition = Continuous**). The distance between successive prints is set with the **Print spacing** parameter.
- ◆ The **Print spacing** parameter defines the distance between the beginnings of prints that are made repeatedly (**Printout repetition >1**). The distance is given as a number of millimeters.

NOTE: If the distance set with the **Print spacing** parameter is smaller than the print length, prints are printed one just after another.

- ◆ The **Print direction** parameter defines in which side the printer should be moved in order to make a print.
 - ↔ – a print is made when the printer is moved left and right,
 - → – a print is made only when the printer moves right. The system detects any movement of the printer in the opposite direction automatically and interrupts printing. When the printer starts moving right again, it resumes the printing from the point at which it moved in the opposite direction. In order to ensure that a printout hits precisely the point at which the printer moved in the opposite direction and the printing was interrupted, lower roll **3** of the printer must have continuous contact with the surface to be labeled.
 - ← – a print is made only when the printer moves left. The system detects any movement of the printer in the opposite direction automatically and interrupts printing. When the printer starts moving left again, it resumes the printing from the point at which it moved in the opposite direction. In order to ensure that a printout hits precisely the point at which the printer moved back and the printing was interrupted, lower roll **3** of the printer must have continuous contact with the surface to be labeled.

-  – a print is made when the printer moves left or right. The direction of printing is chosen with a first movement of a roll. Printing can continue only in the direction originally chosen. The system detects any movement of the printer in the opposite direction automatically and interrupts printing. When the printer moves in the original direction again, it resumes printing from the point at which it moved in the opposite direction. In order to ensure that the printout hits precisely the point at which the printer moved in the opposite direction and the printing was interrupted, lower roll **3** of the printer must have continuous contact with the surface to be labeled.

- ◆ The **Flip horizontal** parameter can be useful if you need to label articles from right to left or if you print on transparent materials and the prints should be legible from the opposite side.

- **disabled**,

TEST 1234567

- **enabled**.

7654321 TEST

- ◆ The **Flip vertical** parameter defines the mode of printing in the vertical direction. It can be normal (mirror image: **disabled**) or turned upside down (mirror image: **enabled**). The parameter is useful when an article to be labeled is turned.

- **disabled**,

TEST 1234567

- **enabled**.

TEST 1234567

- ◆ The **Initial distance** parameter defines the distance from the point where the print release button is pressed to the point where printing of a print should start. The distance is given as a number of millimeters, and it is measured after the trigger has been pressed and before printing starts. It enables you to adjust the print position in relation to the beginning of the article.

- ◆ The **Dot size** parameter is used in order to increase the intensity of prints on porous materials, which absorb ink heavily, on which the characters printed are not well visible due to their grainy structure. An increase in the setting of that parameter results in higher intensity of prints made, owing to

a bigger size of ink drops jetted out of the printer head. Increased intensity involves higher consumption of ink.

Intensity is physically constrained by the real speed at which the head can print – it means that when the intensity is too high for a given printing speed, the printer signals an error with a sound signal (provided that an appropriate warning is set – see **Sound Settings** (p. 23)), and higher intensity also limits the printing speed.

- ◆ With the **Pressure** parameter you can adjust the force by which ink drops are jetted, to the type of surface to be labeled. Lower pressure is recommended for smooth, non-absorbing materials, and higher – for porous, absorbing materials.

If too low pressure is set, ink may solidify on nozzles. If too high pressure is set, irregular ink splashes (so called satellites) may occur around a print.

Detach the ink container from the printer in order to reduce the pressure of the ink in the container, if you need to print a project where lower pressure is set than that in the project printed before.

Touch the  button in order to save the settings of the parameters.

Touch the  button in order to set the parameters that are recommended for a given head type.

Objects

In order to add a new object to a project, choose the type of object from the vertical left-hand, tool bar, and then use the cursor to point out where the object is to be placed within the edit area and press the left mouse button.

Each of the objects can be given an appropriate format, size and location by setting the right parameters. All the objects used in the project are put on the list of objects – see **List of Objects** (p. 105).

Common Parameters of Objects

For text objects you can change the type of font by choosing a new or another font in **Font name** drop-down list. If there is no font that you might be interested

in the drop-down list, you can add your own font by touching the  button (see **Font Manager** (p. 107)).

When EBS built-in fonts are used, you can modify the **Row multiply** and **Letter spacing** parameters. The **Row multiply** parameter defines how many times printing of every vertical row of text is to be repeated. The multiplication of rows is used in order to increase intensity of prints on porous materials, which absorb ink heavily, on which and the characters printed (consisting of the same size dots) are not well visible due to their grainy structure or in order to increase the text width. The **Letter spacing** parameter defines the space between object characters. The space is given as a number of vertical rows (up to 1000 rows).

When True Type fonts (default and user fonts) are used, you can modify the **Font size** parameter (given as a number of pixels). The parameter is linked with the **Constrain proportions** parameter. The **Font size** (font width and height) can be modified proportionally (when the **Constrain proportions** check box is

ticked) or either of the components, the width (**X**) and the height (**Y**) can be modified independently (the **Constrain proportions** check box is unticked).

With the **Line spacing** parameter you can add spaces between lines of text. The spaces are measured in pixels (dots). Up to 20 pixel spaces can be added. The space is added after every end-of-line character.

The object and object frame sizes are subject to **Scaling**. Three options are available:

- ◆ **Without scaling** – it enables you to modify the size of an object frame without changing the size of the object.
- ◆ **Fit frame to content** – when the object frame is to be of the same size as the object.
- ◆ **Fit content to frame** (not available to text objects where an EBS built-in font is used and to barcode-type objects) – when the size of an object is to be the same as the size of the frame.

If the **Transparent** parameter check box is ticked, the object is transparent and you can see an object that is 'under' it. This property is useful when a number of objects have been placed in the edit area and there is a risk that objects overlap each other.

The **Object rotation** parameter allows you to rotate the entire object clockwise (the setting of 90), counterclockwise (the setting of 270) or "upside down" (the setting of 180).

The **Position** parameter shows the coordinates of the top left-hand corner of the object frame. You can modify the coordinates and thereby change the position of the object. Place the cursor in the **Position** field and modify the coordinates in the window displayed. The first coordinate determines the location in the horizontal direction (**x coordinate**), the second one determines the location in the vertical direction (**y coordinate**). The repositioning operation can also be performed in the edit area by holding the cursor on the object and shifting it in any direction.

The **Object size** parameter defines the size of an object frame. Place the cursor in the **Object size** field and modify the size components, (**width** and **height**) in the window displayed. The resizing operation can also be performed in the edit area, by holding the cursor on the bottom right-hand corner of the object and dragging it in any direction (no frame can be resized if **Scaling** is set to **Fit frame to content**).

The **Position** and **Object size** parameters are particularly useful when you need to arrange or align two or more objects precisely.

The **Object name** parameter is designed for identification of an object in the object list. The type of object and a number are used as the object name, as standard (e.g. Text 1, Counter 2). You can give your own name to objects to facilitate identification, but the same names must not be used, i.e. they must be unique within one project. If you use a name that has already been used within the project, an error is reported when you try to save the parameters of the object named so.

If you tick the **Show preview** check box, an object preview is displayed in the top left-hand corner of the screen.

Text Objects

Text Object – Normal Text

Touch the  button and then  in order to add a new, **Normal text**-type text object to a project.

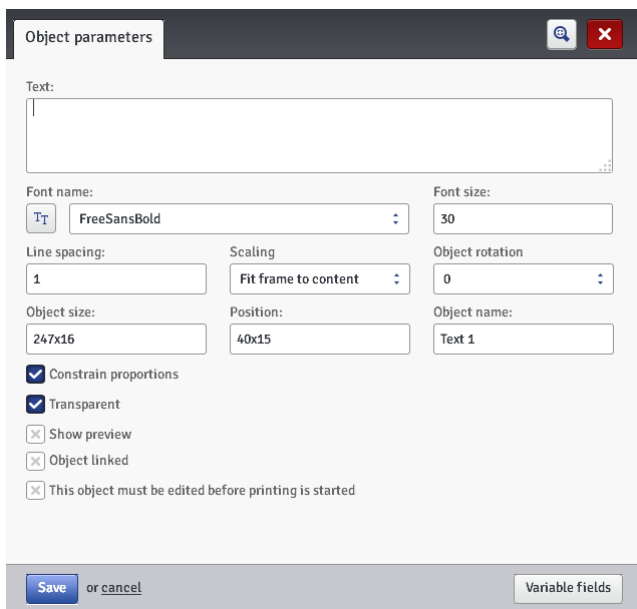

The screenshot shows the 'Object parameters' dialog box. It has a title bar with a search icon and a close button. The main area contains several fields and checkboxes:

- Text:** A large empty text input field.
- Font name:** A dropdown menu showing 'FreeSansBold'.
- Font size:** A text input field showing '30'.
- Line spacing:** A text input field showing '1'.
- Scaling:** A dropdown menu showing 'Fit frame to content'.
- Object rotation:** A dropdown menu showing '0'.
- Object size:** A text input field showing '247x16'.
- Position:** A text input field showing '40x15'.
- Object name:** A text input field showing 'Text 1'.

At the bottom, there are several checkboxes:

- Constrain proportions
- Transparent
- Show preview
- Object linked
- This object must be edited before printing is started

At the very bottom, there is a 'Save or cancel' button and a 'Variable fields' button.

You can type in any characters string in the **Text** field. The division of a text into lines can be done by pressing the ENTER button on the computer keypad.

You can convert a **Normal text**-type object into another text object with the



button.

If the **Object linked** check box is ticked, the object assumes the setting of the object chosen in the drop-down list. Another text object or a barcode can be used as object linked.



If you need to edit your text just before it is printed, tick the check box for **This object must be edited before printing is started**. The object parameters

can be modified in the window that is displayed when the  button is touched.

Touch the  button in order to confirm the settings and to add the object to a project.

Text Object – Date/Time

The **Date/Time** text object allows you to print the current date and the current time and also an expiration date automatically.

Touch the  button and then the  button in order to add a new, **Date/Time**-type text object to a project.

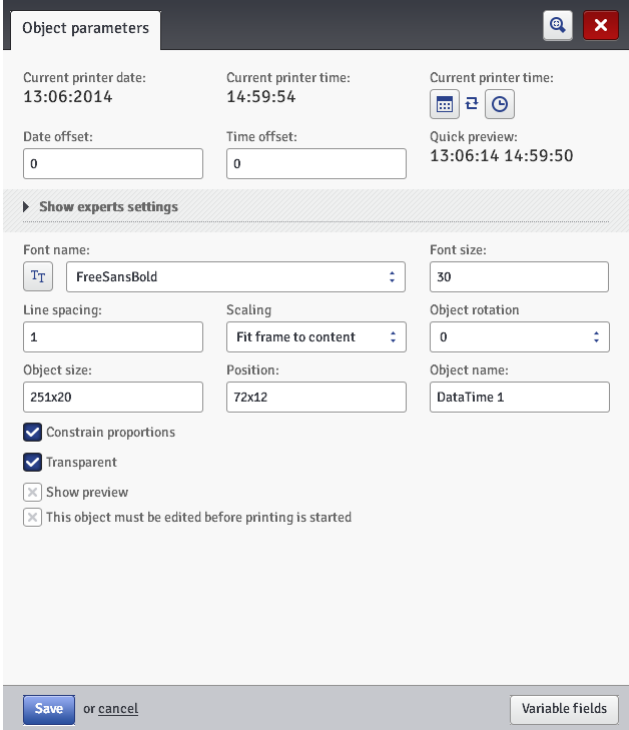

The screenshot shows the 'Object parameters' dialog box for a Date/Time text object. The dialog has a title bar with a search icon and a close button. The main area is divided into several sections:

- Current printer date:** 13:06:2014
- Current printer time:** 14:59:54
- Current printer time:** 13:06:14 14:59:50 (with a quick preview icon)
- Date offset:** 0
- Time offset:** 0
- Show experts settings:** A section with a right-pointing arrow and a dotted line separator.
- Font name:** FreeSansBold (with a font icon)
- Font size:** 30
- Line spacing:** 1
- Scaling:** Fit frame to content
- Object rotation:** 0
- Object size:** 251x20
- Position:** 72x12
- Object name:** DateTime 1
- Constrain proportions
- Transparent
- Show preview
- This object must be edited before printing is started



At the bottom, there is a 'Save' button, a 'cancel' link, and a 'Variable fields' button.

The **Current printer date** parameter shows the current date indicated by the printer

The **Current printer time** parameter shows the current time indicated by the printer.

The **Date offset** parameter allows you to shift the current date by a set number of days, in order to include the expiration date, for example.

The **Time offset** parameter allows you to readjust the current time by a set number of hours (up to 24). The modification can impact on date shifting. Such a change may cause a calendar day to start at a different time than 00:00 (e.g. at 6 o'clock a.m., when a morning shift in the factory starts).

By touching the  calendar or  clock button you can choose components for printing – the date, the time or both of them. With the  arrow icon you can change the order of these components.

When more advanced functions are needed, use expert mode (**Show experts settings**). In the expert mode you can modify separators and date and time format, and also choose other date and time components and separators that are not available in the standard version (with the **Formatting string** parameter).

The **Date separator** parameter allows you to choose a separator to be used between date components for a project. The **Time separator** parameter allows you to choose a separator to be used between time components for a project.

The **Date format** parameter allows you to choose the sequence of date components for a project. The **Time format** parameter allows you to choose the sequence of time components for a project.

The default settings of the date and time formats and separators for newly created **Date/Time**-type text objects can be modified in the Settings menu – see **General Settings** (p. 113).

The **Formatting string** parameter is available when the relevant check box is ticked. Below there are the characters that are used to code the date and time components. Any characters that are different from the below listed, and also spaces, can precede, separate or follow the components of the universal-date variable field. If no local name exists, an equivalent in English is displayed.

- %a – local abbreviation for day of the week (Mon, ... , Sun),
- %A – local full name of day of the week (Monday, ..., Sunday),
- %b – local abbreviation for month (Jan, ... , Dec),
- %B – local full name of month (January, ... , December),
- %c – local date and time in the following format: abbreviation for day of the week, abbreviation for month, day of the month, hours, minutes, seconds, year,
- %C – number of century,
- %d – day of month (01, ... , 31),
- %D – date in mm/dd/yy format,
- %e – day of month (1, ..., 31),
- %F – date in yyyy-mm-dd format,
- %g – 2-figure year corresponding to week number %V,
- %G – 4-figure year corresponding to week number %V,
- %h – local abbreviation for the name of month (Jan, ... , Dec),
- %H – hour, in the 24-hour system (00-23),
- %I – hour, in the 12-hour system (01-12),
- %j – day of the year (001, ... , 366),
- %k – hour, in the 24-hour system (0-23),
- %l – hour, in the 12-hour system (1-12),
- %m – number of month (01, ... , 12),
- %M – minute (00, ... , 59),

- %p – local equivalent of AM or PM (empty in many localizations),
- %P – local equivalent of a.m. or p.m. (empty in many localizations),
- %r – time in the 12-hour system in the following format: gg:mm:ss [AM] or [PM],
- %R – time in the 24-hour system in the following format: gg:mm,
- %s - number of seconds from 00:00:00, 1 January 1970 (the GNU extension),
- %S – second (00, ..., 60); 60 means leap second,
- %T – time in the 24-hour system in gg:mm:ss format,
- %u – day of the week (1, ... ,7); 1 stands for Monday,
- %U – number of week in the year (00, ... , 53), Sunday is the first day of the week,
- %V – number of week in the year (01, ... , 53), Monday is the first day of the week,
- %w – number of day in the week, 0-Sunday, 1-Monday, etc.,
- %W – number of week in the year (00, ... , 53), Monday is the first day of the week,
- %x – local representation of date,
- %X – local representation of time,
- %y – last two digits of year (00, ... , 99),
- %Y – year in yyyy format,
- %z – time zone in the numerical form of RFC-2822 (e.g. +0100) (non-standard extension),
- %Z – time zone (e.g. EDT) or nothing, if no time zone can be defined.

You can convert a **Date/Time**-type object into a different type of text object with the  button.

Touch the  button in order to confirm the settings and to add the object to a project.

Text Object – Counter

The **Counter** text object allows you to print automatically a consecutive number on every successive article to be labeled. The setting of the counter changes each time the trigger is pressed.

Touch the  button and then the  button in order to add a new, **Counter**-type text object to a project.

Object parameters
🗨️ ✖

Increment order:

⏪ >
⏸ >
⏩

Counter 1

Show this counter

Min	<input type="text" value="0"/>	Max	<input type="text" value="99"/>	Start mode	<input type="text" value="Min"/>	Start value	<input type="text" value="0"/>	Last value	<input type="text" value="0"/>
Step	<input type="text" value="1"/>	Length	<input type="text" value="1"/>	Fill in	<input type="text" value="0"/>	Suffix	<input type="text"/>	Event	<input type="text" value="Do nothing"/>

▶ Show experts settings

Font name:

Line spacing:

Object size:

Constrain proportions

Transparent

Show preview

This object must be edited before printing is started

Font size:

Scaling:

Position:

Object rotation:

Object name:

or

The **Counter** consists of a cascade of three identical sections. For simple counting of articles, it is enough to use one, the first section and the default settings to create a counter-type object. When more advanced functions are needed, use expert mode (**Show experts settings**). All counter sections are visible in the expert mode. Each of the sections can be visible (displayed) or not. If you know the configuration of one section, you can easily configure the other as they are identical.

By touching  you can change the **Increment order**. The parameter defines which of the sections is considered as first and what the timing order is. The section timed first receives a timing pulse whenever a print is to be made. Every successive section receives a timing pulse from the previous section, when that section has counted to the end (that is, to the **Max** setting when the counter is incremented or to the **Min** setting when it is decremented). The timing pulse modifies the counter by a set **Step**.

Counter parameters:

- ◆ **Min** – the setting from which counting starts (for counting up), or with which counting finishes (for counting down).
- ◆ **Max** – the setting at which a counter overflows. When the counter overflows, counting starts again from the **Min** setting.
- ◆ **Start mode** – the parameter allows you to set the value from which counting starts after printer operation has been resumed. Four options are available:
 - **Min**,
 - **Max**,
 - **Start value**,
 - **Last value**.
- ◆ **Start value** – the counter setting from which counting starts after operation has been interrupted, e.g. when the batteries discharge. This is effective when the **Start mode** parameter is set to **Start value**.
- ◆ **Last value** – the last setting of a counter, which is saved after the printer has been switched off in regular mode.
- ◆ **Step** – a counter increment. When the setting is a positive number, counting is incremental, and when it is a negative number, counting is decremental.
- ◆ The **Length** parameter is used to adjust the number of counter digit positions to that required by the user.
- ◆ The **Fill in** parameter is used to define a replacement for insignificant digits of a counter: 0 or space.
- ◆ **Suffix** – any character string to follow the counter printout, limited to 41 characters.

With the  button you can modify **Start value** and **Last value**. The parameter is available for the counters that have their **Start mode** parameters set to **Start value**.

If you need to edit your counter just before it is printed, tick the check box for **This object must be edited before printing is started**. The value from which counting starts can be modified in the window that is displayed when the

 button is touched.

You can convert a **Counter**-type object into another type of text object with the  button.

Touch the  button in order to confirm the settings and to add the object to a project.

Text Object – Communications port

The **Communications port** text object is used to print automatically the data received by the printer from external devices (e.g. a computer, automatic scales, a barcode reader).

Touch the  button and then the  button in order to add a new, **Communications port**-type text object to a project.

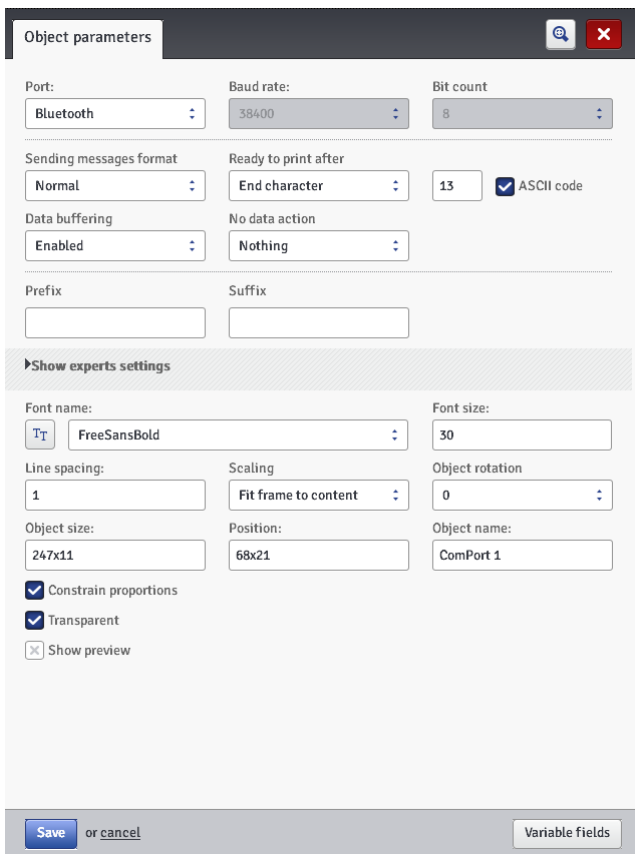

Object parameters

Port: Bluetooth Baud rate: 38400 Bit count: 8

Sending messages format: Normal Ready to print after: End character 13 ASCII code

Data buffering: Enabled No data action: Nothing

Prefix: Suffix:

Show experts settings

Font name:  FreeSansBold Font size: 30

Line spacing: 1 Scaling: Fit frame to content Object rotation: 0

Object size: 247x11 Position: 68x21 Object name: ComPort 1

Constrain proportions
 Transparent
 Show preview

Save or cancel Variable fields

When added to a project, the **Communications port** object is highlighted (e.g. in blue). This means that its contents during printing depends on data transferred to the communication port. If a greater number of **Communications port** objects are used, each of them is highlighted in a different color.

For a **Communications port** object you can set the parameters that are significant for establishing communication between the printer and an external device. The printer and the device must have the same settings of the following parameters to communicate successfully:

- ◆ **Port** – it defines the name of a printer port to which an external device is connected as a source of serial transmission signals in RS–232 standard, for example. There is no physical RS–232 interface in the printer, so you need to apply a USB – RS232 converter in order to connect an external

device. With such a converter you can connect an external device (e.g. a computer, automatic scales, a barcode reader) to a USB port. External devices can be connected to the printer via a Bluetooth interface, which is a source of serial transmission signals and can be chosen in this object. The list of ports is fixed and contains Bluetooth and ports, from COM1 to COM9.

- ◆ **Baud rate** – it signifies a rate of transmission (a number of symbols per second) through the port. The list to choose from contains the most typical rates used for serial communication. If the **Port** parameter is set to Bluetooth, the **Baud rate** setting cannot be modified.
- ◆ The **Bit count** parameter defines the number of bits in every portion of the data transferred. If the **Port** parameter is set to Bluetooth, the **Bit count** setting cannot be modified.

Communication Parameters – they define the rules for communication between the printer and an external device:

- ◆ **Sending messages format** – this parameter defines the format of data to be transferred from the printer to a device. Two modes are available: **Normal** and **Hexadecimal**. In the normal mode, the data is transferred as ASCII characters, whereas in the hexadecimal mode it is transferred as hex numbers.
- ◆ **Ready to print after** – it defines how the printer decides whether it has received complete data (the end condition) from an external device or not. The following modes can be set in this parameter:
 - **Time interval (ms)** – the printer waits for data over a certain time. The time is counted from the moment when a last project is printed or, if the **On processing data** field (in expert settings) is filled in – from the moment when an end-of-printing acknowledgement is sent. The time is typed in in the field next to the parameter as a number of milliseconds (between 4 and 1000 ms). If no data is received within the defined time, the printer behaves according to the **No-data action** setting.
 - **Data amount** – the printer is ready for printing a project containing a **Communications port** object when it receives a number (from 1 to 255) of characters from the external device; with the number being defined in the field next to the parameter. If printing is released although the condition is not met (the defined number of characters has not been received) the printer behaves according to the **No-data action** setting.
 - **End character** – the printer is ready for printing a project containing a **Communications port** object when it receives data ending with a defined character from an external device, with the character being defined in the field next to the parameter. In this mode you can also define an ASCII character that is to be the end of a portion of the data received. For that purpose, tick the **ASCII code** check box and type in the ASCII code in decimal notation. If printing is released when the condition is not met (a defined end-of-data character is not received) the printer behaves according to the **No-data action** setting.
- ◆ **Data buffering** – it is used for storing successive data portions in a variable field, **Communications port**. Two modes can be set:
 - **Enabled** – a successive portion of the data received by the variable field is stored if the end condition is met – see **Ready to print after**. The

buffer size is 20, which means that 20 various, ready-to-print pieces of data can be received and stored. When any other data comes, it will overwrite the data at the 20th position and a long sound is heard at the same time to inform about an overflow. The buffered data forms a kind of queue, the data is printed in the same sequence in which it has been received by the variable field. If all the data buffered is printed, and another print is released, the printer behaves according to the **No-data action** setting.

- **Disabled** – a successive portion of the data received by the variable field overwrites the data that has been received earlier but has not been printed yet. The data is overwritten until it is printed. If no other data is received subsequently, the printer behaves according to the **No-data action** setting. In this mode, the printer always prints the last or latest data received.



◆ **No-data action** – it defines printer behavior when no data has come from an external device (when the end condition is not met – see **Ready to print after**) and printing of a project containing a **Communications port** object has been released. The following modes of operation can be set:

- **Nothing** – if printing is released when data is not received properly or the end condition is not met (see **Ready to print after**), the project is not printed. The message informing about this fact is displayed.
- **Print blank object** – the project is printed as usual, with the entire **Communications port** object being empty. NOTE! If a **Prefix** and/or a **Suffix** are defined by the user, they will not be printed.
- **Print last message** – the project is printed together with the **Communications port** object, with the object being filled with the last message received successfully from the external device. If such a printout is made as a first, the project is printed but the area where the data should be is empty. NOTE! If a **Prefix** and/or a **Suffix** are defined by the user, they will be printed. The maximum number of repetitions defines how many time the last message can be printed. If the number of printouts is achieved, every successive release of printing make the printer react according to the **Nothing** mode.

Printing Parameters – they define how the data transferred via a communications port is to be printed. The parameters are hidden by more advanced, expert mode parameters that correspond to them – see below.

- ◆ **Prefix** – a text in a **Communications port** object, which is printed before the data received from an external device.
- ◆ **Suffix** – a text in a **Communications port** object, which is printed after the data received from an external device.

Expert Settings – they define the rules for processing of the data received from an external device, and also the mode of acknowledgement of printer states transferred to the device, *i.e.* starting printing, stopping printing, project printed:

- ◆ **On starting printing** – it defines the data to be transferred from the printer to the external device immediately after printing has been initiated (with the  button on the **Printer control** panel).
- ◆ **On processing data** – it defines the data to be transferred from the printer to the external device each time a project containing the **Communications port** object has been printed.
- ◆ **On finishing printing** – it defines the data to be transferred from the printer to the external device immediately after printing has been stopped (with the  button on the **Printer control** panel).
- ◆ **Script name** – with this field you can choose a script to which data is transferred for processing before it is printed (it allows you to search for data for printing in, for example, a database, Excel files, a csv file, etc.). Scripted files must be stored in the **custom_data** folder in the user partition of internal printer memory. The partition can be accessed in a network environment. For more information on the subject of scripts refer to the document entitled *Managing the processing of data transferred by COMMUNICATIONS PORT in the EBS printers*.
- ◆ **Proc Formatting String** – this is an advanced mode of formatting of the data transferred from an external device to the printer. It describes how the incoming data is interpreted by the Printing Manager. Markers applied: %s – a character string, %d – a number.
- ◆ **Separator data count** defines to how many parts the data transferred via the communications port is to be divided. If the parameter is set to 1, everything transferred to the communications port is to be printed in the object. Otherwise, the user can choose to which of the objects each of the data portions transferred via the communications port should go, with the first part always going to that object. When the **Separator data count** parameter is set to a value greater than 1, the following options are additionally available:
 - **Separator character** – it defines the character that separates portions of the data transferred via the communications port from each other. Additionally, you can give the ASCII code of the character that is used as a separator of the data to be received. For that purpose tick the **ASCII code** check box, and type in the ASCII code of the data separator in decimal notation in the **Separator character** field.
 - **Object X** – it means the name of an object to which the separated data portion received via the port and defined by X should go. You can only choose from the objects that are used for a given project and to which this data can go. The maximum number of separated portions of data is 10 (if a project contains 12 objects, the data can be divided into 10 of them). The object containing a portion of the data transferred via the communications port is additionally highlighted in a color.

►Show experts settings

On starting printing:	On processing data:	On finishing printing:
<input type="text"/>	<input type="text"/>	<input type="text"/>
Script name:	Formatting string:	
No script ▾	%s	
Separator data count		
1 ▾		

You can convert a **Communications port**-type object into another text object with the **Variable fields** button.

Touch the **Save** button in order to confirm the settings and to add the object to a project.

Text Object – Text File

The **Text file** text object is used for printing the data stored in a TXT file.

Touch the **T** button and then the **File** button in order to add a new **Text file**-type text object to a project.

Object parameters 🔍 ✖

File path:

Line count: 1 ▾	Line step: 1 <input type="text"/>	Line max: 0 <input type="text"/>
Line start value: 1 <input type="text"/>	Start mode: Start value ▾	Last value: 0 <input type="text"/>

Font name: T FreeSansBold ▾	Font size: 30 <input type="text"/>
Line spacing: 1 <input type="text"/>	Scaling: Fit frame to content ▾
Object size: 247x14 <input type="text"/>	Object rotation: 0 ▾
Position: 64x18 <input type="text"/>	Object name: TextFile 1 <input type="text"/>

Constrain proportions
 Transparent
 Show preview

Save or cancel
Reset V.F.
Variable fields

Touch the **Browse** button and choose a file name out of those listed in the window displayed, and then touch the **Select file** button in order to roll-in the text file.

The parameters of a **Text file** object are as follow:

- ◆ **Line count** – the number of lines to be added to the object from the text file.
- ◆ **Line step** – the number of lines by which text file data moves each time a print is made. If the **Line count** is greater than the **Line step**, the data moves by the number of lines given in the **Line count**.
- ◆ **Line max** – the last line of text to be included in a printout.
- ◆ **Line start value** – the text line to be added to an object as a first one.
- ◆ The **Start mode** parameter is used to define which line of the text file is to be rolled-in after printer operation has been resumed. Two options are possible:
 - **Start value** – the line defined by the setting of the **Line start value** parameter is to be rolled-in,
 - **Last value** – the line shifted by the **Line step** in relation to the line on which printing finished is to be rolled-in.
- ◆ **Last value** indicates the line that has been last printed. The line is stored in memory provided that the printer is switched off properly – see **Switching the Printer Off** (p. 16).



With the  button you can modify the **Line start value** parameter. The parameter is available for the counters whose **Start mode** parameter is set to **Start value**.

You can convert a **Text file**-type object into another type of object with the  button.

Touch the  button in order to confirm the settings and to add the object to a project.

Image

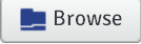
Touch the  button in order to add a new, **Image**-type object to a project.

Touch the  button in order to roll-in an image from printer memory for printing, choose a file name in the window displayed, and then touch the  button (see **Image Manager** (p. 106)). The printer can process PNG files.

Object parameters

Object name:
Image 1

Image path:
Browse

Object size: 247x16 Position: 37x14 Object rotation: 0

Scaling
Fit frame to content

Transparent

Show preview

Save or cancel

Touch the  button in order to confirm the settings and to add the object to a project.

Barcode

The barcode can have the following forms:

- ◆ **Normal barcode**,
- ◆ Barcode containing a **Date/Time**, **Counter**, **Communications port** or **Text file**-type variable field.

Object parameters

Barcode type:
Internal EAN-13

Text:
[Empty field]

Auto adjust text

Font name: MTCORVA Font size: 20

Object rotation: 0 Object size: 32x32 Position: 74x26

Object name:
Barcode 1

Constrain proportions Signature Auto-size

Transparent

Show preview

This object must be edited before printing is started

Save or cancel Variable fields

The following types of barcodes are available:

- ◆ Numerical: EAN–2, EAN–5, EAN–8, EAN–13, EAN–5 + EAN–2, EAN–8 + EAN–2, EAN–8 + EAN–5, EAN–13 + EAN–2, EAN–13 + EAN–5, Code 25, Code 11, Code 25 Industrial, Code 25 Interleaved, Code25 IATA, Code 25 Data Logic, Codabar, Leticode, Identcode, GS1 DataBar–14, GS1 DataBar Limited, GS1 DataBar Expanded, UPC–A, UPC–E, PostNet, MSI Plessey, Pharmacde One–Track, Pharmacde Two–Track, ITF–14, PZN.
- ◆ Alphanumeric: Code 39, Code 39 Extended, GS1–128 (UCC/EAN–128), Code 128, Code 16k, Code 93, Telepen Alpha, 2D:PDF417, 2D:PDF417 Turncated, 2D:QR Code, Australia Post 4–State, Royal Mail 4–State (RM4SCC), 2D:Data Matrix, 2D:MicroPDF417.

Fill the **Text** field with a string of characters that are to be presented in the form of a bar code. Remember to adjust the type of code to the quantity and kind of characters. The detailed information on the format of each of the codes are displayed while the type of code is being selected. When the field changes color to red, this means that the character string typed in is not appropriate to a given code type (a wrong number or type of characters).

If the **Auto adjust text** check box is ticked, the size of the code **Signature** is adjusted to the barcode size. If the **Auto adjust text** check box is unticked, you can modify the **Font name**, **Font size** settings and modify the **Constrain proportions** parameter.

You can modify the following parameters in a barcode object:

- ◆ **Border type** – the type of barcode frame (it is available for selected codes, and does not apply to internal codes); three types are available:
 - **none** – there is no frame,
 - **bind** – frame lines at the top and bottom of the code,
 - **box** – frame lines on each side of the code.
- ◆ **Border size** – the width of a barcode frame (it is available to selected codes and does not apply to internal codes), it allows you to modify the frame width when the **Border type** is set to **bind** or **box**.
- ◆ If the **Constrain proportions** check box is unticked (this field is available when the **Auto adjust text** check box is unticked), **Font size X** and **Font size Y** can be modified.
- ◆ The **Signature** check box defines whether a given code is to have its value typed in explicitly or not. Some codes, especially 2D ones, cannot be displayed together with a description, and if the check box is ticked for that type of code, no description can be added to a code symbol.
- ◆ If the **Auto-size** check box is ticked, the object frame is of the same size as the object size. If the check box is unticked, the frame size can be modified without any change to the object height.

If you need to edit your barcode just before it is printed, tick the check box for **This object must be edited before printing is started**. The code can be

modified in the window that is displayed after the  button has been touched.

You can convert a **Normal barcode**-type object into another type of barcode with the  button. This allows you to present **Date/Time**, **Counter**, the date transferred from an external device via a **Communications port** and the data from a **Text file** with a barcode.



Touch the  button in order to confirm the settings and to add the object to a project.

Shape-type Objects

Shape-type objects are placed in the edit area by drawing a required shape. When you click within the edit area, a first component of a shape (e.g. the end of a line, a vertex of a rectangle) is put there. Then, when you move the mouse cursor, a preview of the object to be added is generated, whereas when you click again in the edit area, the object, which was previewed while the mouse cursor was being moved after the first click, is added.

Shape-type Object – Line

The shape-type object – **Line** allows you to print a continuous line.

Touch the  button and then  to add a new, **Line**-type object to a project.

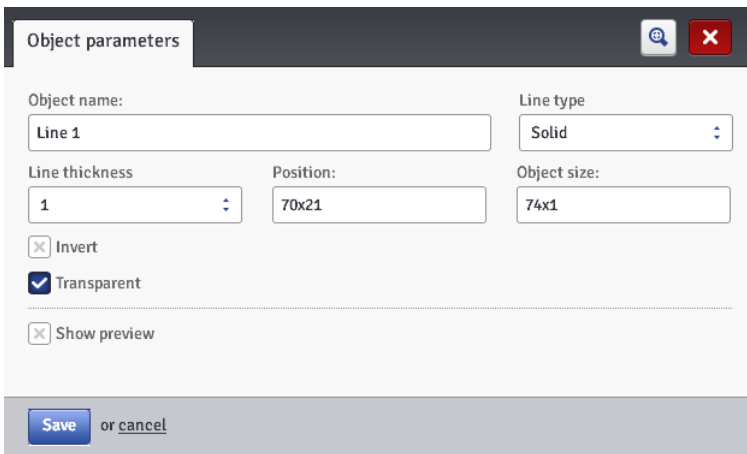

You can set the **Line thickness** in the range from 1 to 30. the **Line thickness** is given as a number of dots (pixels).

If the **Invert** check box is ticked, then where the **Line** "covers" another object that might be in a lower layer, the common section of the line and that other object is not printed.

Touch the **Save** button in order to confirm the settings.

Shape-type Object – Rectangle

With the **Rectangle** object you can print any rectangle: an outline only or the entire figure (in the latter case the **Filled** check box needs to be ticked).

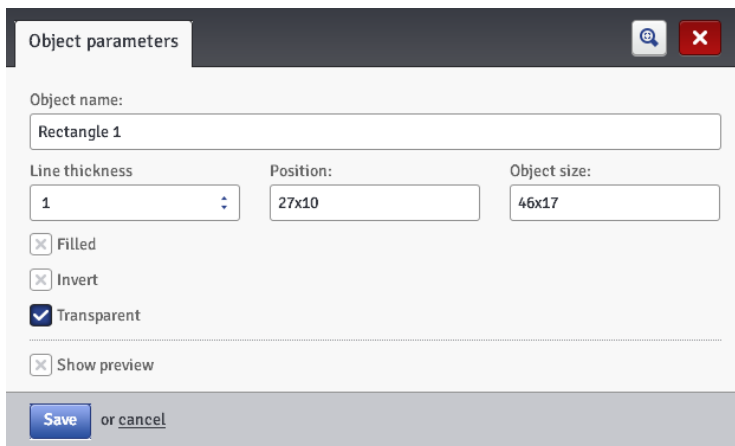

If the **Invert** check box is ticked, then where the **Rectangle** "covers" another object in a lower layer, the common section of the rectangle and another object is not printed.

With the **Line thickness** parameter you can set the thickness of the rectangle outline. The parameter is disabled when the **Filled** check box is ticked.

Touch the  button in order to confirm the settings.

Shape-type Object – Ellipse

The **Ellipse** object allows you to print any ellipse: an outline only or the entire figure (in the latter case the **Filled** check box needs to be ticked).

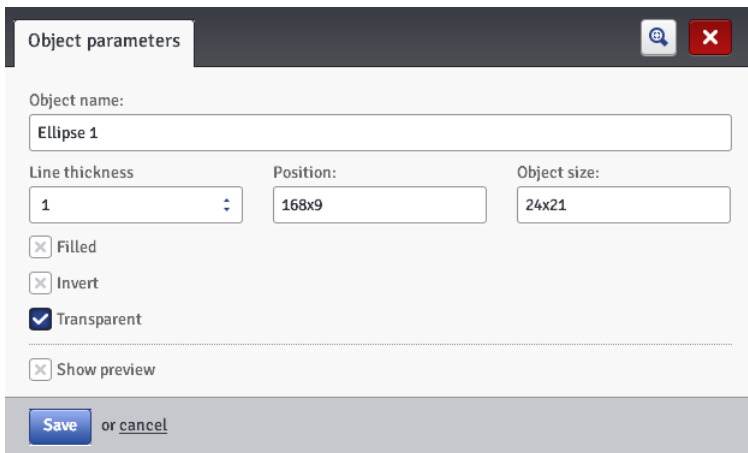

Object parameters

Object name:
Ellipse 1

Line thickness: 1
Position: 168x9
Object size: 24x21

Filled
 Invert
 Transparent
 Show preview

Save or cancel



If the **Invert** check box is ticked, then where the **Ellipse** "covers" another object in a lower layer, the common section of the ellipse and that another object is not printed.

With the **Line thickness** parameter you can set the thickness of the ellipse outline. The parameter is disabled when the **Filled** check box is ticked.

Touch the  button in order to confirm the settings.

Line Divider

If a division mark is added to a project, you can make printouts of several text files quickly on successive lines or on various spots on an article.

Touch the  button and then touch the  button in order to add a new, **Line divider**-type text object to a project.

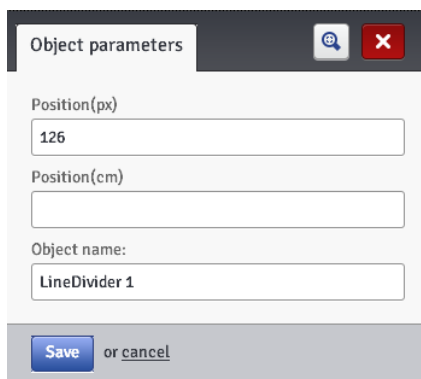

With the **Position(px)** or **Position(cm)** parameter you can define the number of the vertical row on which the division should be made. You can start modifying and printing divided projects by pressing trigger **6**.



Touch the  button in order to abandon adding the division mark.

List of Objects

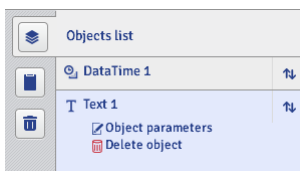
The list of all objects used for a project is accessible with the  button on the vertical right-hand tool bar.



When you click with the left mouse button on the object name, the object is highlighted in blue and a drop-down menu is displayed. The menu contains the object parameters and a delete button. If the object name is highlighted in red, this means an error (the type of error is displayed on the **Messages** (p. 117) screen in the bottom section of the Browser window). The following operations can be performed on the object list:



- ◆ You can change the sequence of objects in the list and thereby the sequence in which objects are arranged in the edit area (the last object in the list is positioned in the lowest layer, the first one – in the highest layer) with the  button,
- ◆ You can edit a highlighted object; you can touch the  button in order to open the object parameter window,
- ◆ You can delete a highlighted object with the  button – the deleted object is moved to trash – see **Trash** (p. 106).

Clipboard

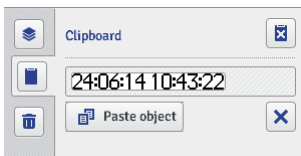
The **Clipboard** is accessible with the  button on the vertical right-hand tool bar.



The following operations can be performed on clipboard objects:



- ◆ You can delete one or all objects from the clipboard with the  button,
- ◆ You can paste an object put into the clipboard to a project with the  button.

Trash

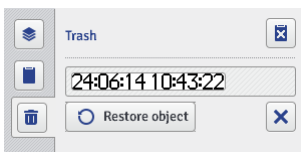
The **Trash** is accessible by touching the  button on the vertical right-hand tool bar.





The following operations can be performed on trash objects:

- ◆ You can delete one or all objects from the trash with the  button,
- ◆ You can restore a highlighted object into the list of objects with the  button.

Tools

Image Manager

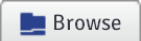
In the **Tools** menu, which is on the menu bar, you can choose **Images manager**. With the Manager you can do the following:

- ◆ You can save a new image in printer memory with the  **Install new image** button. In the window displayed should touch the text field or the  button and choose an image to be installed from computer disc. Confirm the operation with the  button. The number of images you can install is constrained by the printer memory available.



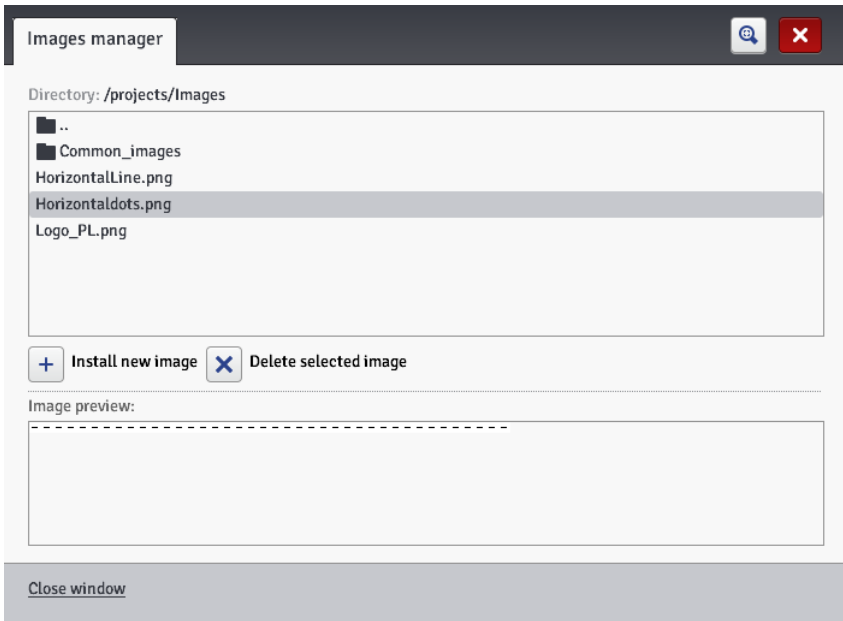

- ◆ You can delete an image from printer memory – by highlighting the image name in the list and touching the  button.



EN

Font Manager



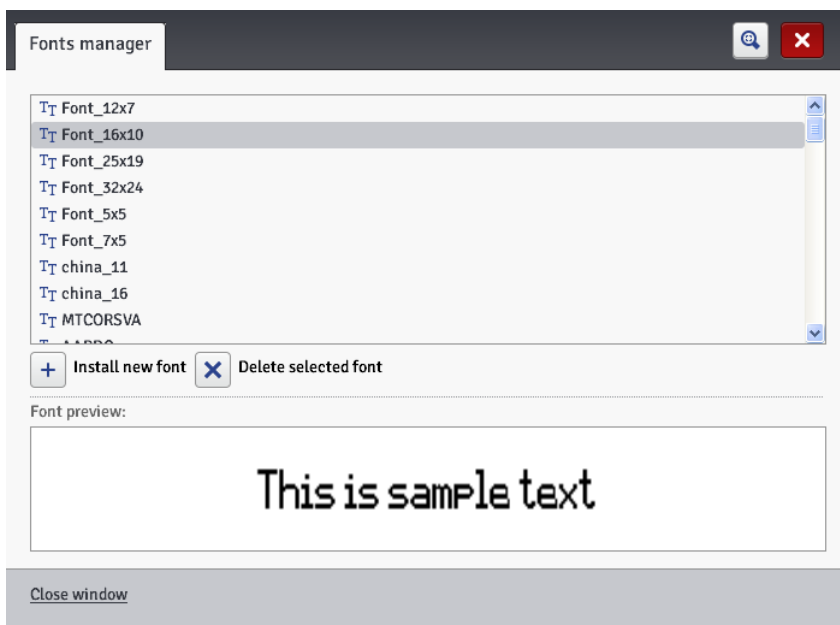

In the **Tools** menu, which is on the menu bar, you can choose **Fonts manager**. With the Manager you can do the following:

- ◆ You can add a new font with the  **Install new font** button. In the window displayed touch the text field or the  **Browse** button and choose a font to be installed from computer disc. Confirm the operation with the  **Install selected font** button. Before a font is installed, it is recommend that the license for using the font be read. The number of fonts you can install is constrained by the printer memory available.
- ◆ You can delete a font from printer memory – by highlighting the font name in the list and touching the  button.



Text Files Manager



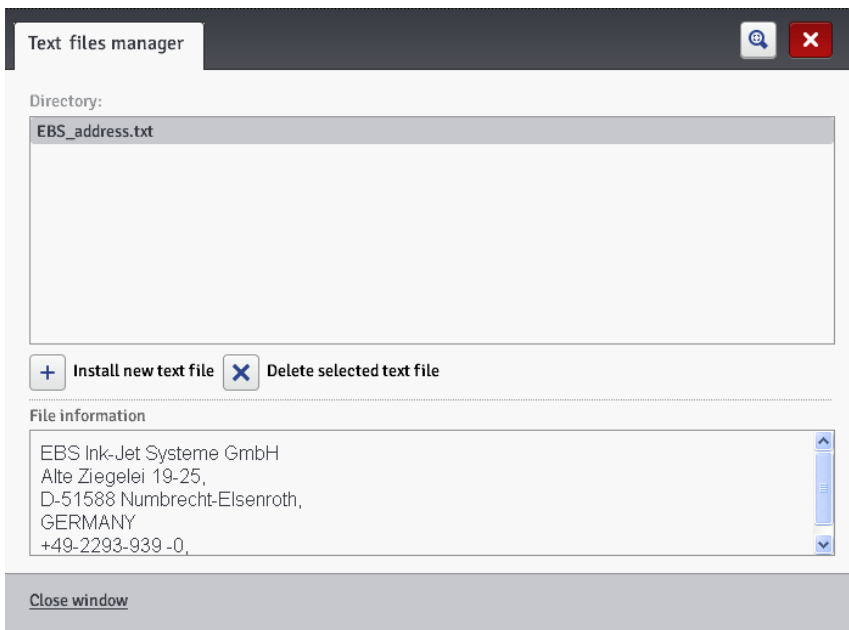

In the **Tools** menu, which is on the menu bar, you can choose **Text files manager**. With the Manager you can do the following:

- ◆ You can add a new text file with the  **Install new text file** button. In the window displayed touch the text field or the  button and choose a file to be installed from computer disc. Confirm the operation with the  button. The number of files you can install is constrained by the printer memory available.
- ◆ You can delete a text file from printer memory – by highlighting the file name in the list and touching the  button.



Users Manager

In the **Tools** menu, which is on the menu bar, you can choose **Users manager**. The Manager functions are available for users who belong to the Administrator group. With the Manager you can do the following:







- ◆ You can add a new user by touching the  button. In the window displayed you should type in your **Login**, **Password** and **Retype password**. You can add an image to identify the user – touch the text field or the  button and choose a file from computer disc for reading-in. Confirm the operation with the  button. Tick the check box next to the group to which the user it to belong.
- ◆ You can edit the existing user data by highlighting the user name in the user list and touching the  button.
- ◆ You can delete a user by highlighting his name in the user list and touching the  button.
- ◆ You can enable automatic logging in of a selected user when *Web User Interface* starts running, by ticking the **Enable Auto-Login** check box and choosing the user name in the drop-down list.

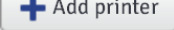

Two access groups: **Administrator** and **Operator**, are important for a printer user. **Administrator** and the users added to the **Administrator** group have access to the project and parameter processor, to the printer tools and control and they can also add new users and edit and delete existing ones. **Operator** and the users added to the **Operator** group have access only to printer operations: they can create a project for printing, start and stop printing. The unavailable options are in gray.

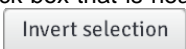
Printers Network Manager

In the **Tools** menu, which is on the menu bar, you can choose **Printers network manager**. With the Manager you can do the following:

- You can add a new printer to a network by touching the  button. In the window displayed, type in the **Printer name** (a name that facilitates identification of the printer in the list) and the **Printer IP** and choose the **Printer model** in the drop-down list and then touch the  button.
- You can add a new printer to a network by touching the  button. The environment is searched and the printers available are listed. You can expand you network by adding a selected printer by ticking the check box that is near the printer name or all printers by touching the  button and then the  button.
- You can edit the data of a printer that is in the list by highlighting the printer name and touching the  button.
- You can delete a printer from the list by highlighting the printer name and touching the  button.

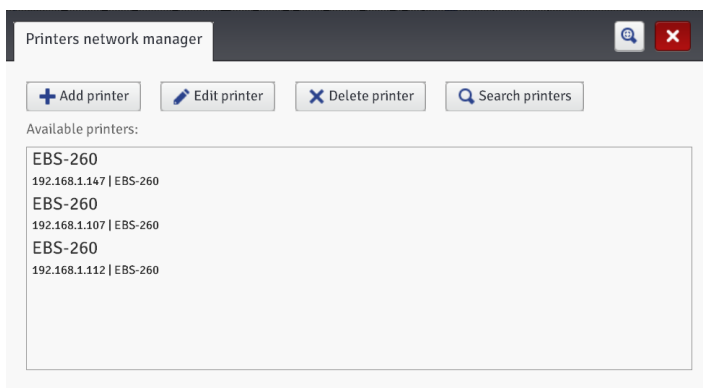

You can manage the listed printers via a printer network. The printer network window is accessible by touching the **Printers network** button, which is on the *WUI* bottom bar – see **Work Screen of EBS Web User Interface** (p. 74).

In the **Printers network** window you can see the list of printers together with the following data:

- ◆ Type of printer,
- ◆ Printer IP address,
- ◆ Printing status,
- ◆ Batteries status,
- ◆ Ink container status.



Point out the name of a printer with the cursor and press the left-mouse button. A pop-up or pop-down menu appears. With this menu you can do the following:

- ◆ Open the printer control window – see **Printer Control** (p. 116),
- ◆ Transfer a project to the printer – see **Export Project** (p. 79),
- ◆ Open *EBS Web User Interface*,
- ◆ Restart the printer,
- ◆ Switch the printer off.

Language Manager

In the **Tools** menu, which is on the menu bar, you can choose **Language manager**. The processor starts running and in the window displayed

you can modify the menu names, key labels and the messages that are displayed on the printer LCD and in the printer processor. Choose the language that you wish to edit in the drop-down list, and then choose **Editor** (*EBS Web User Interface* messages) or **LCD** (printer messages). On modifying a text touch the  button at the bottom of the page.

Account Manager

In the **Tools** menu, which is on the menu bar, you can choose **Account management**. With this tool you can manage the data on the account of the currently logged-in user.

You can re-name the user. For that purpose delete the name used so far in the **Login** field and type in a new name.

In order to change the password of a given user, type in the **Old password**, and then type in and repeat a **New password**. The new settings are available after they have been confirmed with the  button.

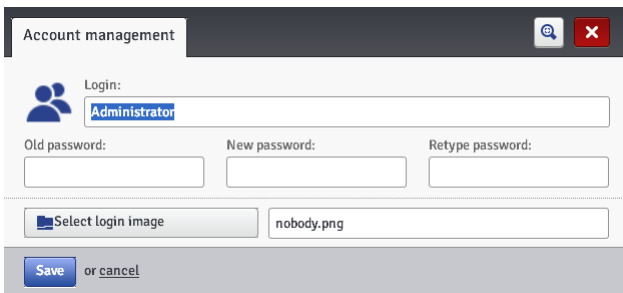

Workspace width

In the **Tools** menu, which is on the menu bar, you can choose **Workspace width**. With that tool you can set the width of the edit area precisely. The setting can be made in pixels (**px**) or centimeters (**cm**) by

choosing the proper field. Confirm the new setting with the  button. The tool is available when a project is open and can be edited.

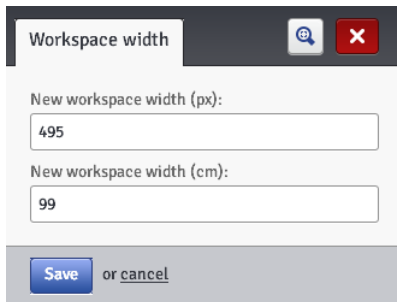

Simulate Printout

In the **Tools** menu, which is on the menu bar, you can choose **Simulate printout**. With this tool you can make a test printout and figure out what your project will look like in reality.

The tool is available when a project is open and can be edited. The Brower option for displaying pop-up windows should be enabled.

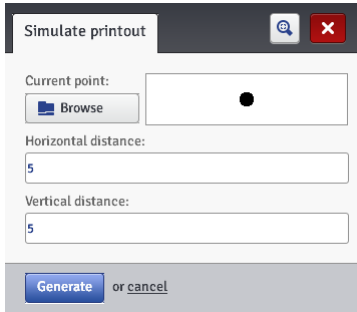

Simulate printout

Current point:

Browse

Horizontal distance:

5

Vertical distance:

5

Generate or cancel

EN

Settings

General Settings

In the **Settings** menu, which is on the menu bar, choose **General settings**.

In the **General settings** sheet tab you can set the **Language** for communication with the processor and enable **Statistics** (see **Operating Statistics** (p. 117)). The new settings should be approved with the

Save changes

button.

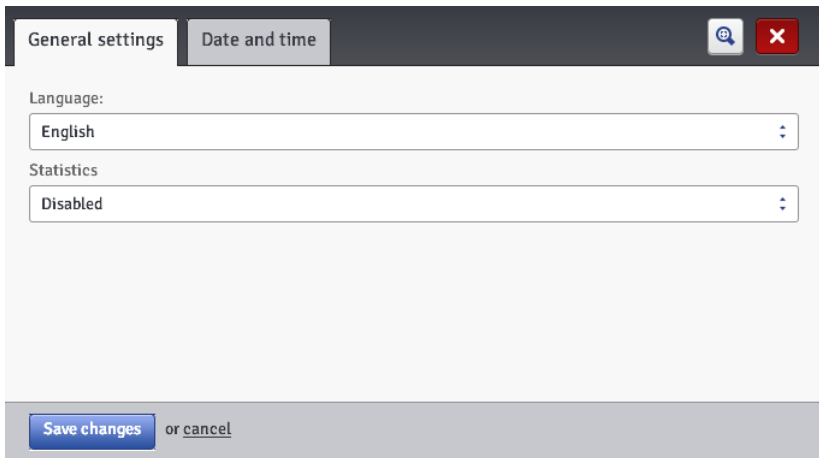

General settings Date and time

Language:

English

Statistics

Disabled

Save changes or cancel

In the **Date and time** sheet tab you can set the date and time parameters (i.e. the date and the time, data and time formats and separators as the default format for newly created **Date/Time**-type text objects).

The date and time that are displayed after the **General settings** menu has appeared are the actual date and the real time generated by the printer clock.

You can save any date and any time in the printer by modifying the **Date (da-mo-year)** and **Time (hr:min:sec)** settings and transferring them to the printer

with the  button.

You can harmonize the computer and printer date and time settings by touching the  and  buttons in turn.

Any changes to date and time formats and to separators are confirmed with the  button.

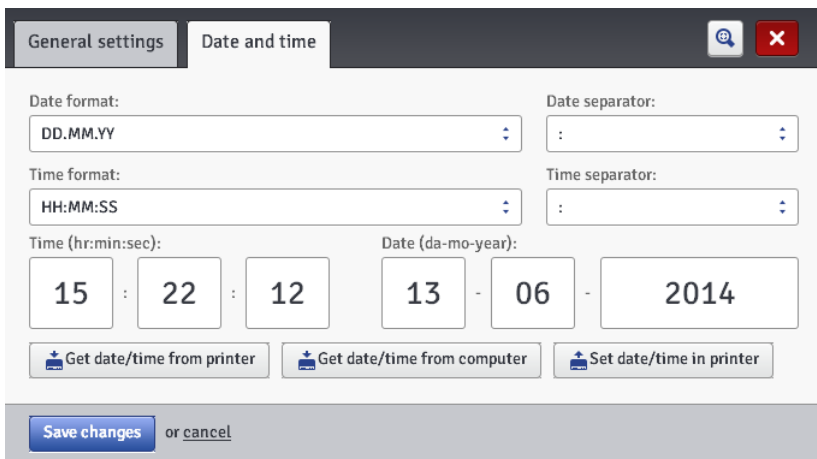

Service

Update

In the **Service** menu, which is on the menu bar, choose **Update**.

Owing to software updates the printer always has up-to-date and improved software, which makes it function better.

New versions of the software are stored on the printer web site at <https://handjet.com/download/> in the Information Materials sheet tab. The update may involve a loss of projects and user-specific settings, and also the deletion of fonts and images installed. Make sure that the projects and files you wish to save have been backed up before updating – see **Exporting Projects** (p. 35) via the printer (only projects are exported) or **Export Project** (p. 79) via *EBS Web User Interface* (projects and images are exported).

Touch the  button. On the screen displayed choose an update file with the extension EBS in the list and touch the **Open** button.

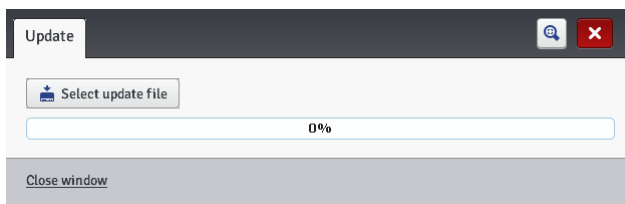

Log

In the **Service** menu, which is on the menu bar, choose **Log**.

The **Log** window shows all the events (e.g. user logging in, opening and editing a project, starting printing, etc.) that took place both during printer operation, **Printer log** and when the processor was used, **Editor log**. When you switch

from one option to the other touch the  **Reload log file** button in order to update the data displayed.

Generate Service Report

In the **Service** menu, which is on the menu bar, choose **Generate service report**. This function enables you to generate an electronic report on the condition of the printer. Should a problem with the printer occur, the report shall be e-mailed to a distributor or a point where the printer can be serviced. This is a prerequisite for starting the service procedure. An analysis of report by specialist personnel facilitates identification of the problem that occurred during printer operation.

The service report can also be used for activating a new option if a problem with standard activation occurs. The information contained in the service report forms the basis for generation and transfer of a file that makes the activation of that new option possible – see **Install Option** (p. 116).

When the following window is displayed after the **Generate service report** command has been given, this means that the report is being generated.

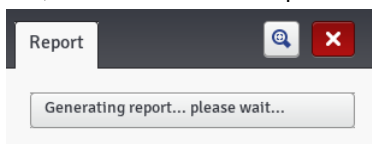

When the report is generated, the window changes its appearance to:

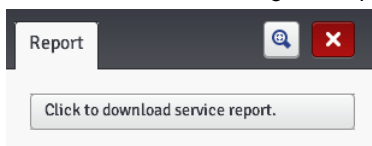

Touch the  button and then choose where the report file is to be saved on computer disc.

Install Option

In the **Service** menu, which is on the menu bar, choose **Install option**.

This function allows you to add various software options according to user requirements. Consult specialist personnel dealing with printer distribution and service about the possibility of adding dedicated software.

Choose a file that is on computer disc by touching the text field or the



button in order to install an additional option. When the file is

chosen, the text field box shows a path. Touch the  button in order to add the selected option to printer software.

LCD Preview

In the **Service** menu, which is on the menu bar, choose **LCD Preview**.

Owing to the preview function you can use the processor to see what is displayed on the printer LCD and also to operate the printer with the mouse.

The image is refreshed at a time interval to be chosen in the drop-down list when the **Auto refresh after** check box is ticked.

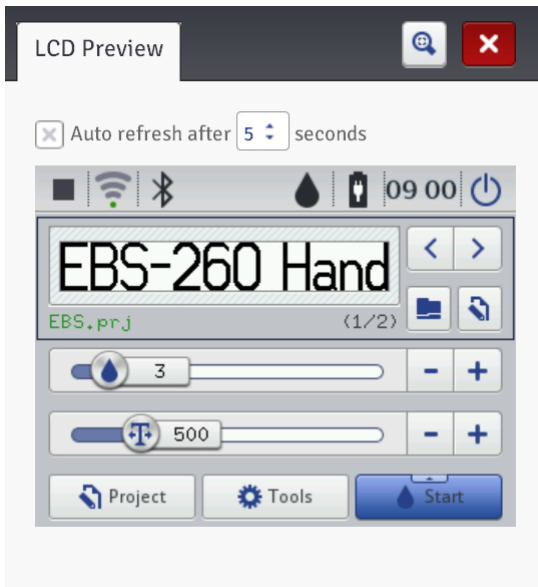

Printer Control

See **Printing a Project via Web Browser** (p. 122).

The **Printer control** menu is not available to *Offline WUI*, but you can manage operation of a selected printer via a printer network – see **Printers network** (p. 111).

Info

About

In the **Info** menu, which is on the menu bar, choose **About**.

In the window displayed you can view the manufacturer's contact details and the version of printer software.

For the user who operates the printer on a standard basis, it is important to have the information on the version of the system (**System version**). Owing to it you can check whether you have up-to-date software on the printer.

The other version numbers and also the serial number of the printer are necessary for service persons to perform diagnostic operations.

EN

Operating Statistics

In the **Info** menu, which is on the menu bar, choose **Operating statistics**.

In the window displayed you can view the data on the number of hours the printer has run (work time) and on the number of prints made, split by user report and service report (general statistics). The user report is generated for all users generally. If you wish to obtain a separate report for a given user, clear the statistics at the beginning of work. For that purpose tick the

User info report check box and then touch the  button.

Additional statistics showing the number of prints made for each of the projects are available after the **Statistics** parameter has been set to **Enabled** – see **General Settings** (p. 113).



The report is updated after printing has been disabled (see **Printing a Project** (p. 119)) and the statistics window has been closed and opened again.

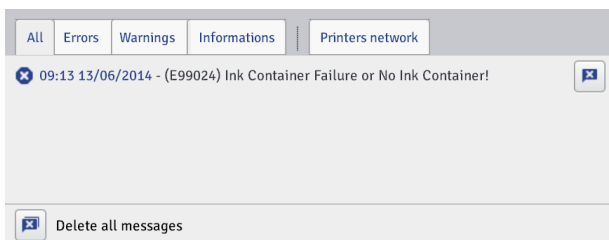

Messages

Important information about printer operation is signaled with the message window at the bottom of the *EBS Web User Interface* work screen.



The information is collected in four sheet tabs:

- ◆ All messages,
- ◆ Error messages ,
- ◆ Warning messages ,
- ◆ Info messages .

The messages are displayed one below the other. You can delete one message with the  button or all messages with the  button.

If there are no messages at any moment, the message window is pulled up.

Printing



Each time the printer is switched on, precede the target printout with a test printout in order to make sure that all printing parameters are set properly and the nozzles jet ink drops properly.

Opening Project for Printing

Opening a Project for Printing via Printer LCD

Open a project for printing with the  button (**L**) or choose a project with the  or  buttons to switch between projects within a given folder.

The project open for printing can be edited before printing. You can modify the following:

- ◆ The project contents – by touching the  edit button (**M**), and then the **Project** button,
- ◆ Printing parameters (basic) with sliders in the printing parameter windows on the main screen,
- ◆ Printing parameters (general) – by touching the  edit button (**M**), and then the **Parameters** button.

When the editing is finished, touch the  button (**N**) if you wish to save the changes. If a change is not saved, the project can be printed with the changed contents or parameter setting only until the project is modified again or the printer is switched off.

If you modify a project open for printing or parameters of such a project via a Web Browser, the following message is displayed on the printer LCD:

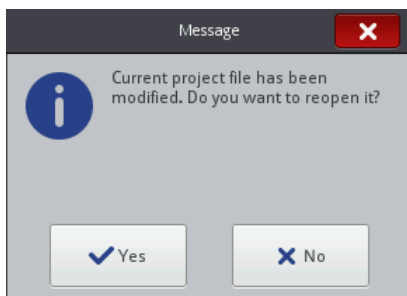

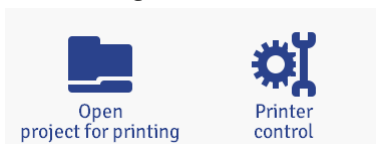

If you wish to print an updated project, touch the **Yes** button.

Opening a Project for Printing via Web Browser



Open a project for printing with the **Open project for printing** button, which is in the **printer control module** of processor edit area (see *Work Screen of EBS Web User Interface* (p. 74)) or



with the  button in the **Printer control** menu.



You can modify printing parameters before printing. For that purpose touch the  button. After you have finished editing, touch the  button. If a modification is not saved, the project can be printed with the changed contents or parameter setting only until the project is modified again or the printer is switched off.

EN

Printing a Project



Printing a Project via Printer LCD

Touch the  button (**W**) or touch button **23** on keypad **10** in order to initiate printing – the printing status changes to  (**Print on (waiting)**). Printing starts when trigger **6** is pressed and the printer moves along an article to be labeled (the lower roll **3** must roll) – the printing status changes to  (**Print on (printing)**).

On touching the  button (**W**) or button **23** on keypad **10**, printing is disabled, and the printing status changes to  (**Print off (ready)**).

The printer is equipped with a practical tool, **Measure**, which is designed for adjusting the print resolution defined for a project to the length of a surface to be labeled.

1. Open a project for making a print whose length you wish to adjust.

2. Touch and hold the  button (**W**) until a drop-down menu appears and touch the  button.



3. On the screen displayed touch the  button.

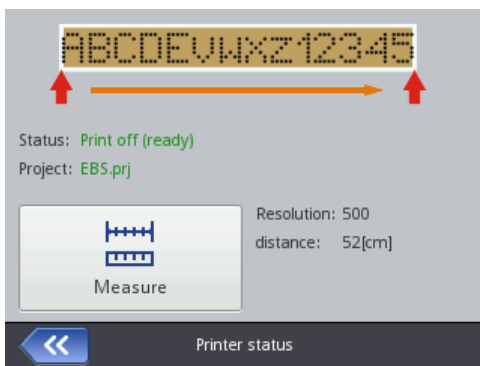

4. Put the printer to the place on a surface where a print is to begin and press trigger **6** on the printer.

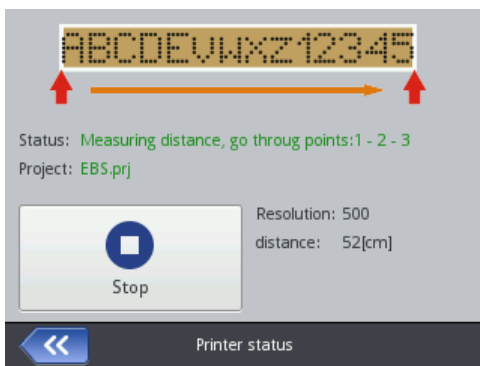

5. Move the printer to the place where the print is to end (lower roll **3** must have permanent contact with the surface to be labeled) and press release **6**.

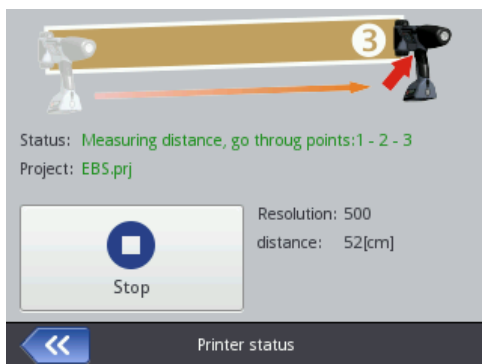
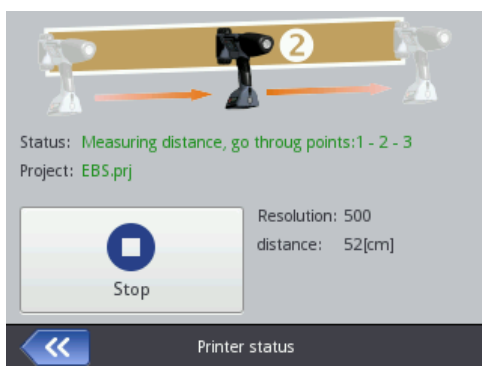
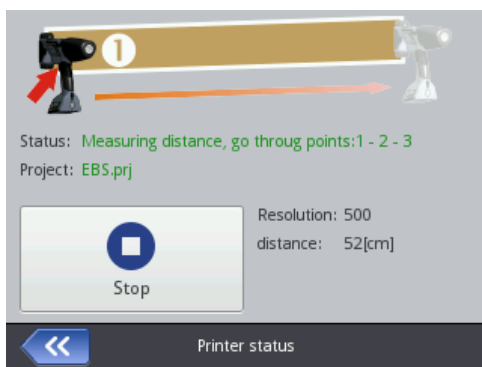

6. Touch the  button.

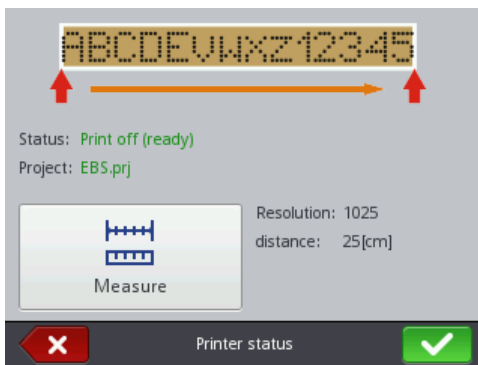

The program calculates the resolution of the print automatically. In addition, the project length is displayed as a number of centimeters (the **distance** parameter).

Printing a Project via Web Browser



Open a project for printing – see *Opening a Project for Printing via Web Browser* (p. 119).

The **Printer status** field in the **Printer control** window shows the information whether printing is initiated and the information on the printing process:

- ◆ **Print off (ready)** – the printer is ready,
- ◆ **Print on (waiting)** – the printer waits until trigger **6** is pressed and lower roll **3** starts moving,
- ◆ **Print on (printing)** – the printer prints.

The **Current project** field shows the name of a project rolled-in for printing. The project last printed is stored by the printer and it is read-in automatically when the printer is restarted.

In addition, the information on ink (**Ink container status**, **Ink level** and **Ink colour**) and also the battery status are displayed.

If the **Enable autostart** check box is ticked, the printer starts printing automatically the project that was previous printed immediately after it is has been switched on.

Touch the **Start printing** button in order to start printing – the printer status changes to **Print on (waiting)**. Printing starts when trigger **6** is pressed and the printer moves along an article to be labeled (lower roll **3** must roll) – the printer status changes to **Print on (printing)**.

Stop printing

When the **Stop printing** button is touched, printing is disabled, and the printer status changes to **Print off (ready)**.

Another project can be read-in for printing by touching the  button. You can change printing parameters before you start printing. The printing

parameter window is displayed with the  button. The parameters apply to the current printing, and they are not saved as the parameters for a given project. Use the **Printing parameters** option in the project processor in order to save the parameters for a given project, and then save the changes for the project – see **Printing Parameters** (p. 83).

EN

Maintenance, Storage and Transport

- ◆ It is recommended that the outer face of the print head, especially the nozzle plate **2**, and possibly the guide rolls **1** and **3** should be washed in order to remove the remnants of ink and dirt after the work has been finished and the printer has been switched off. The washing should be done in the following way:
 - Place the HANDJET printer on its side and tilt its face downwards carefully (see the drawing below); in such a position dirty wash-up can flow freely out of the printer,
 - Place a piece of absorptive cloth or a metal vessel, e.g. a tray, under the printer face,
 - Wash the printer face with the use of a wash-up atomizer.

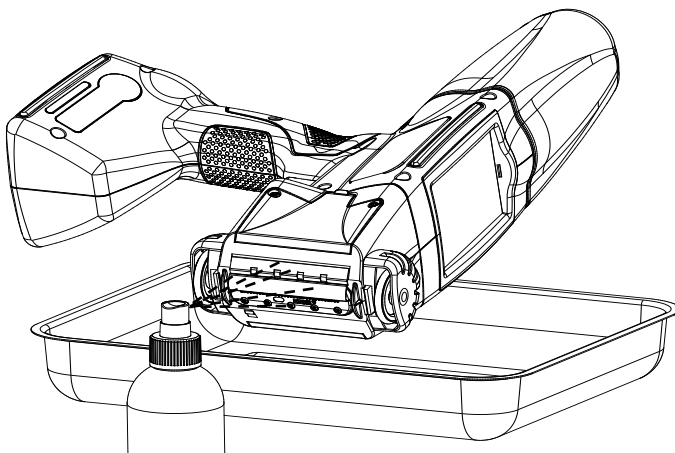

If the printer face is washed in a different way than that shown above, then wash-up may get in to the printer's movable, bearing-based parts or inner electronic subassemblies unintentionally. In effect, the roll guides may seize or ever lockup permanently and the (shaft-encoder) position sensor and other electronic subassemblies may get damaged.

- ◆ If the printer remains idle for a longer period (over 3 weeks), ink may partially dry in printer components. Therefore follow the storage instructions given below:
 - if the printer has already been used before, store it with ink container **13** fastened to it,
 - protect the printer against dust, dirt, any influence of aggressive vapors and gases and excessive temperature and moisture. Ideally, place the printer in a polyethylene tight bag, remove air from the bag and close it tightly. Then place it in the packing case.
- ◆ The printer should be stored and transported in the packing case delivered with the printer. During normal operation avoid exposing the printer to strong mechanical shocks (protect the printer, especially nozzles **2**, rolls **1** and **3**, keypad **10** and LCD touch screen **12** against impact, falling onto hard surfaces or scratching with sharp objects).

User Support

Problems with Functioning and Operation of the Printer

Some of the nozzles do not jet ink

Some drops are missing on a print.

TEST TEST
or TEST

- ◆ Aim the nozzle outlet at a vessel, for example the one you use to wash the printer.
- ◆ Wash the nozzles with wash-up, if they are covered with dried ink.
- ◆ Start the purging function – see **Purging** (p. 70).
- ◆ When ink is jetted out of every nozzle regularly, release trigger **6**.



Frequent and long-lasting use of the purge function increases ink consumption.

The printer does not print

On initiating printing and making an attempt to print you can hear the electromagnets of the nozzle valves operating but ink drops are not always jetted out of the nozzles properly. The quality of printing deteriorates or no print is produced.

This may occur when the ink filter is choked. After about 50 ink containers (or over 10 liters of ink) have been consumed, however not less frequently than every four years, the built-in ink filter should be checked and replaced, if need be. It is recommended that the replacement operation be performed by qualified or EBS service staff.

Boldfaced or Blurred Prints

The print is heavily saturated with ink, ink drops blur and the entire print seems to spread over the object being labeled.

TEST

Reduce the setting of the **Dot size** parameter by touching the „-“ button (**R**) on main screen of the printer or change it by modifying printing parameters – see **Printing Parameters** (p. 65).

Questions and Problems

Should you have additional queries after reading this operating manual, you can:

- ◆ Browse the EBS Ink Jet Systeme, the printer manufacturer's web site
- ◆ Try asking a question to the manufacturer's representative,
- ◆ Present the problem in the contact form available on the manufacturer's web site and forward the form following the instructions given therein.

EN

Technical Parameters

Parameter	Description
Number of nozzles	32
Nozzle diameter	150µm as standard optionally: 120µm, 170µm, 200µm
Print height	56 mm
Height of objects to be labeled	from 115 mm (contact with both rolls), from 39 mm (contact with the lower roll to print with for example 7 nozzles only - see figure D).
Working position in 3D space	any
Number of text lines per run	Up to 4 lines
Maximum number of characters per text	Constrained by internal memory of the printer
Number of projects (stored in the printer's memory at the same time)	Constrained by internal memory of the printer
Printing of graphics (logo, special graphic characters)	Texts and graphic symbols can be edited and printed with the application of True Type fonts and also by means of UTF-8 characters, as standard
Special characters	Diacritical characters, graphic characters for information, warning, transport, etc. purposes

Parameter	Description
Variable fields (texts whose contents vary dynamically according to occurrence of a specific event)	Date and time in any format, expiration date, incremental or decremental counters, cascade counters, barcodes
Timing	Synchronized with rotational speed of the lower guide roll
Printer control, project and printing parameters processing	<ul style="list-style-type: none"> ◆ on the printer LCD, ◆ via Mozilla Firefox® Web Browser (<i>EBS Web User Interface</i> – online and offline).
Printer-computer communication: Operating frequency range: Range:	Wireless link, via radio, Wi-Fi technology 2 400 GHz up to 100 m , according to the lay of the land
Power supply	Battery powered with a pack of 6 Li-Ion cells.
Approximate operating time with the battery fully charged	16 hours calculated for 60 printouts, each 1 m long, and the resolution of 550 dots/m per hour, made at a temperature of about 20°C; automatic low-battery alert
Power supply and Re-charging	During standard operation: battery power – a Li-Ion battery pack (6 cells) While the battery is recharged: mains supply Recharging via an external power pack: IN: 100 - 240 V _{AC} , 50/60 Hz OUT: 24V⁼⁼ / 1.25A Recharging time – shorter than 300 minutes (< 5 h) . Number of recharging cycles: 500 (a minimum of 70% of original capacity)  The HANDJET® EBS-260 printer is not equipped with a disconnecter (a power switch), therefore an AC power socket should be easily accessible for connecting the printer to get the battery recharged.

Parameter	Description
Ink	It is available in easy detachable containers. It is made on the basis of alcohol, acetone or water, in various colors (among others in white, yellow, blue, green, red or black).
Container capacity	200 ml
Working pressure	from 0,015 MPa to 0.045 MPa (from 0.15 bar to 0.45 bar)
Operating temperature range	from +5 °C to +40 °C
Storage temperature range (over a longer period)	from +1 °C to +45 °C , if water-based ink is used for printing. from -10 °C to +45 °C , if acetone or ethanol -based ink is used for printing.
Humidity	Up to 95% without steam condensation - at temperatures higher than the dew point (the printer can be operated when it rains provided that the surface to be labeled is dry).
Weight	1580±10 g printer with a battery and full ink container, without power pack and cable.
Dimensions in vertical position (length / width / height)	330 / 88 / 277 mm
Dimensions in working position	See figure D below (provided that the surface to be labeled is vertical).

EN

Printer Accessories

NOTE: some elements may not be part of a typical delivery or other elements which are not specified below may be included, depending on your order.

The following elements are delivered most frequently as part of a typical unit:

- ◆ Packing case to hold all accessories 1 unit
- ◆ HANDJET® EBS-260 Printer 1 unit
- ◆ Big rolls (for uneven and porous surfaces) 2 units
- ◆ Small rolls (for flat and smooth surfaces) 2 units
- ◆ Power pack (24V==/1.25A) 1 unit
- ◆ Power pack cable 1 unit
- ◆ Ink container 1 unit
- ◆ Sprayer with washer 1 unit

D

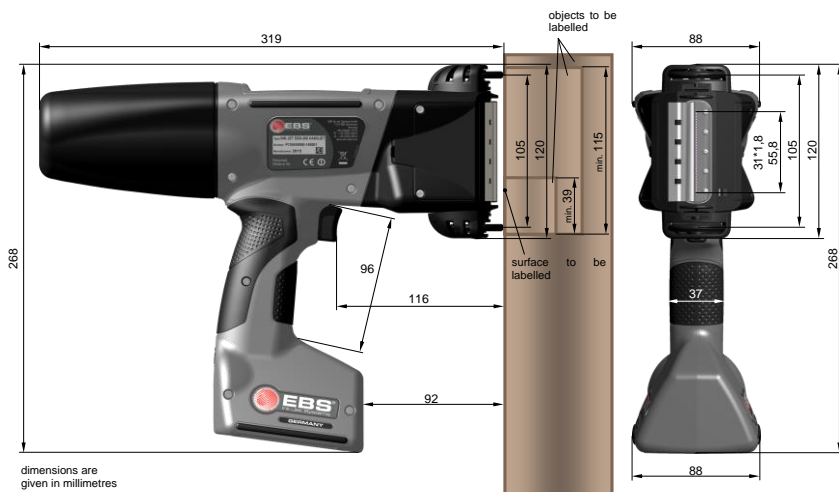

The printer in its working position - dimensions (side and front views)

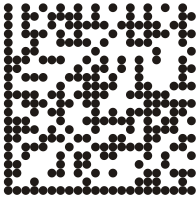

www.ebs-inkjet.com

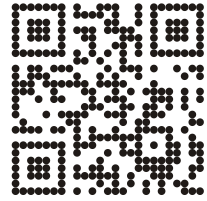

EBS Ink Jet Systeme GmbH
Alte Ziegelei 19-25,
D-51588 Nümbrecht, Germany
☎ +49 (0)2293 - 939-0
📠 +49 (0)2293 - 939-3
www.ebs-inkjet.de

EBS Ink-Jet Systems Poland Sp. z o.o.
ul. Tarnogajska 13,
50-512 Wrocław, Poland
☎ +48 71 367-04-11
📠 +48 71 373-32-69
www.ebs-inkjet.pl

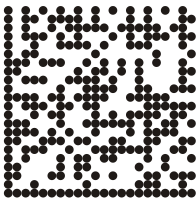

www.handjet.com

